

Arduino基礎教學

控制LED、使用開關

Lesson 0

Arduino

Lesson 0 - Arduino

- 什麼是Arduino?
- Arduino的種類
- 如何取得Arduino?

什麼是Arduino?

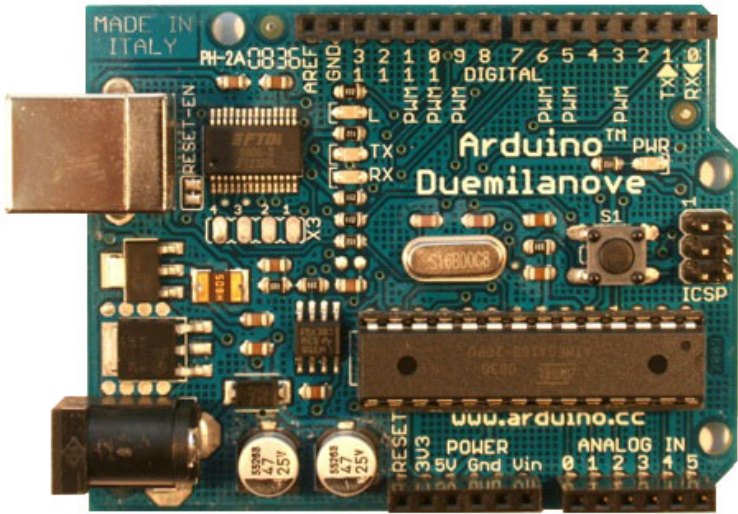

Arduino Duemilanove

- open source
 - 硬體(Arduino I/O board)
 - 軟體(Arduino IDE)
- 能快速製作電子電路原型 (electronics prototyping)
- 有彈性、易使用
- 目標對象：
藝術家、設計師、任何對互動有興趣的人

什麼是Arduino?

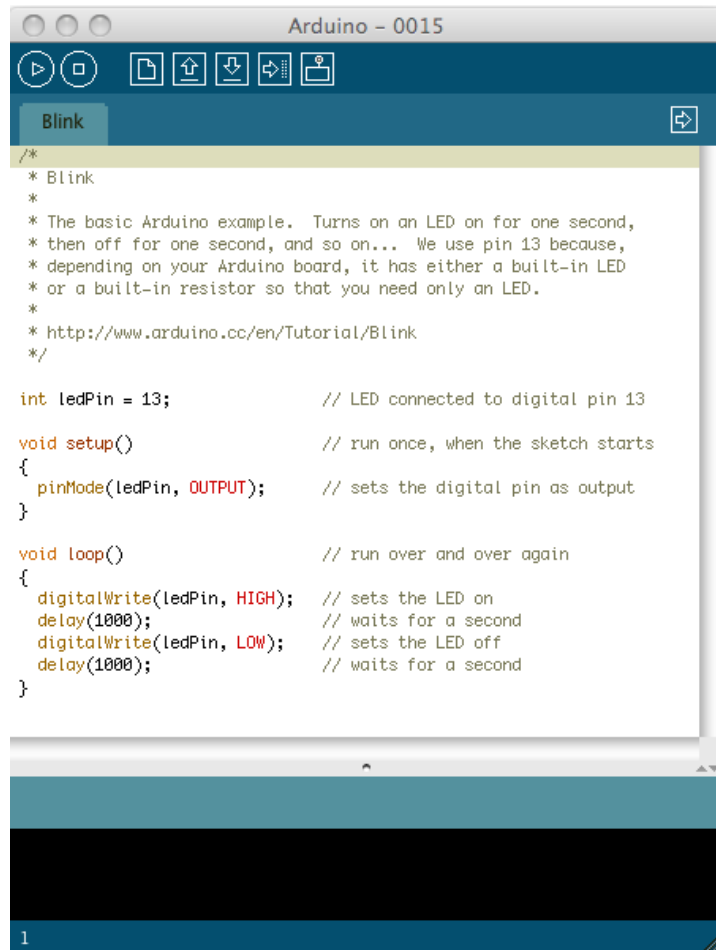
A screenshot of the Arduino IDE interface. The window title is "Arduino - 0015". The menu bar includes "Blink" and a search icon. The main text area contains the following code:

```
/*  
 * Blink  
 *  
 * The basic Arduino example. Turns on an LED on for one second,  
 * then off for one second, and so on... We use pin 13 because,  
 * depending on your Arduino board, it has either a built-in LED  
 * or a built-in resistor so that you need only an LED.  
 *  
 * http://www.arduino.cc/en/Tutorial/Blink  
 */  
  
int ledPin = 13;           // LED connected to digital pin 13  
  
void setup()              // run once, when the sketch starts  
{  
  pinMode(ledPin, OUTPUT); // sets the digital pin as output  
}  
  
void loop()               // run over and over again  
{  
  digitalWrite(ledPin, HIGH); // sets the LED on  
  delay(1000);                // waits for a second  
  digitalWrite(ledPin, LOW);  // sets the LED off  
  delay(1000);                // waits for a second  
}
```

Arduino IDE

- 藉由感應器(sensor)能感知周遭環境變化(如:紅外線感應器)
- 能控制周遭裝置(如:燈)
- Arduino電路可獨自運作
- Arduino電路也可以搭配電腦運作, 跟電腦溝通

什麼是Arduino?

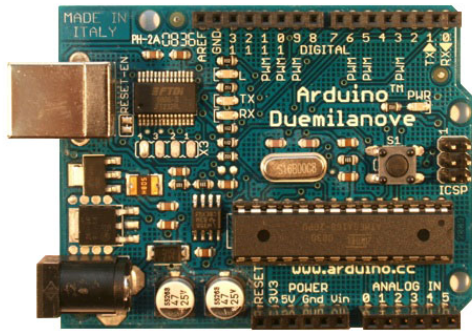

+

```
Arduino - 0015
Blink
/*
 * Blink
 *
 * The basic Arduino example. Turns on an LED on for one second,
 * then off for one second, and so on... We use pin 13 because,
 * depending on your Arduino board, it has either a built-in LED
 * or a built-in resistor so that you need only an LED.
 *
 * http://www.arduino.cc/en/Tutorial/Blink
 */

int ledPin = 13;           // LED connected to digital pin 13

void setup()              // run once, when the sketch starts
{
  pinMode(ledPin, OUTPUT); // sets the digital pin as output
}

void loop()               // run over and over again
{
  digitalWrite(ledPin, HIGH); // sets the LED on
  delay(1000);                // waits for a second
  digitalWrite(ledPin, LOW);  // sets the LED off
  delay(1000);                // waits for a second
}
```

+

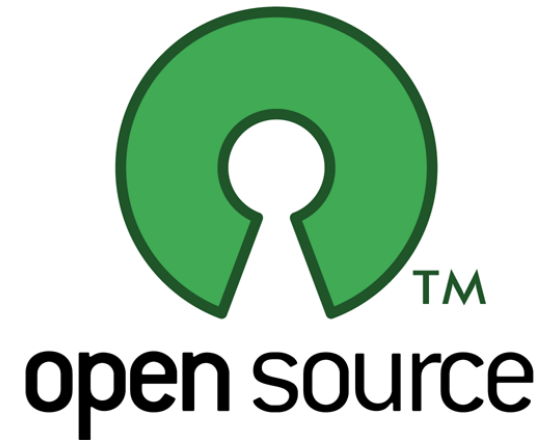

Arduino的種類

- Arduino Duemilanove (這次工作坊用的)
- Arduino Diecimila
- Arduino Nano
- Arduino Mega
- Arduino Bluetooth
- Arduino LilyPad
- Arduino Mini
- Arduino Mini USB Adapter
- Arduino Pro
- Arduino Pro Mini
- Arduino Serial
- Arduino Serial Single Sided

來源網站：<http://arduino.cc/en/Main/Hardware>

Arduino Duemilanove (這次工作坊用的)

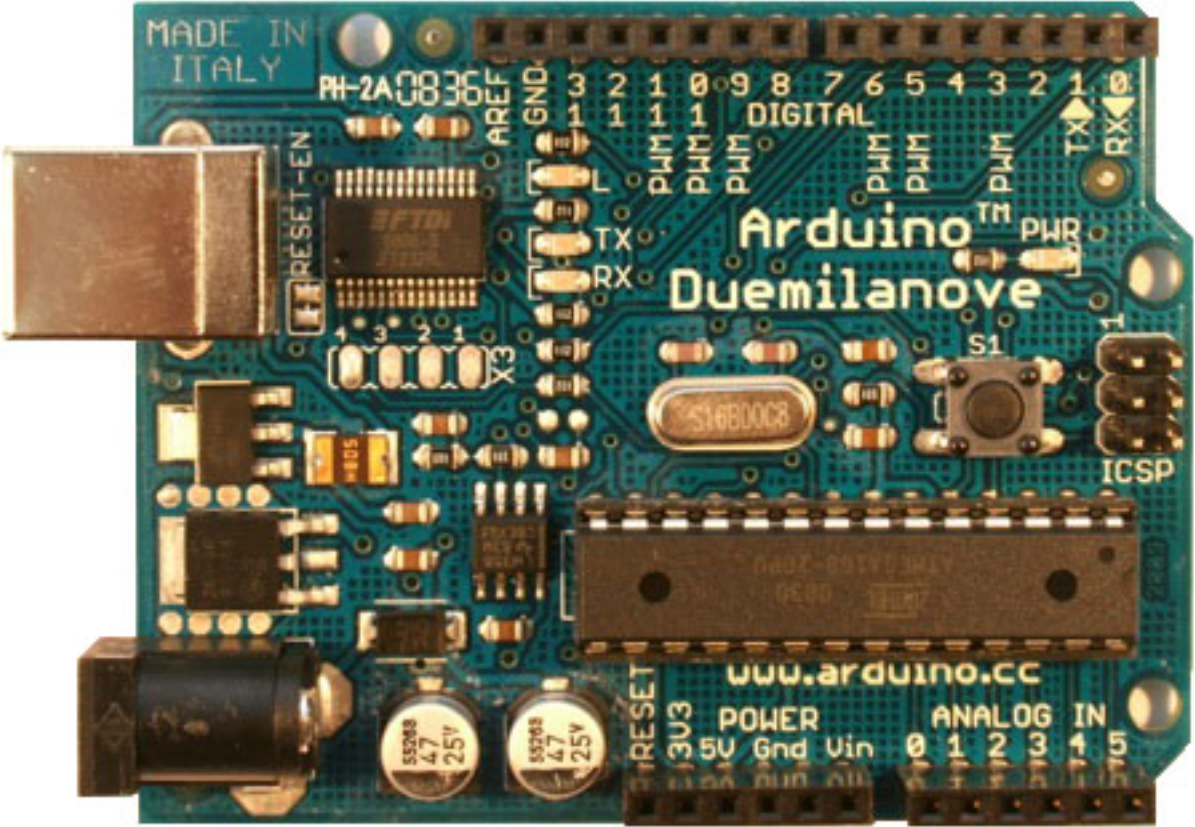

Arduino Diecimila

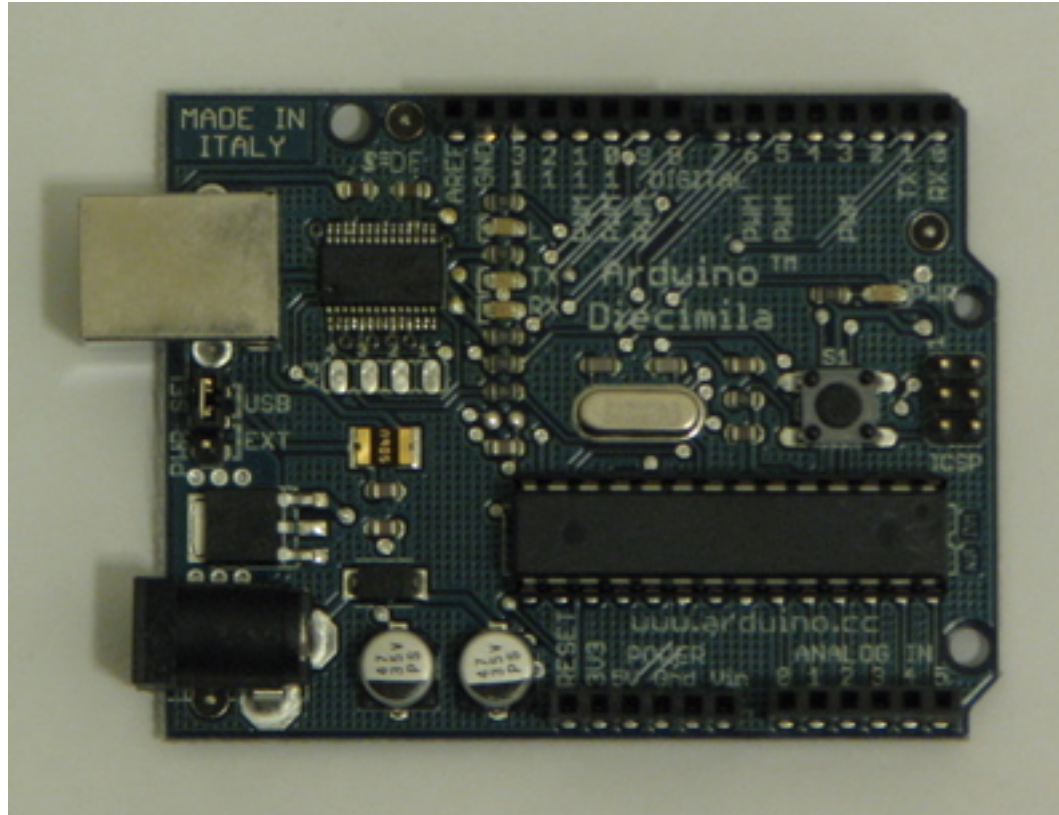

Arduino Nano

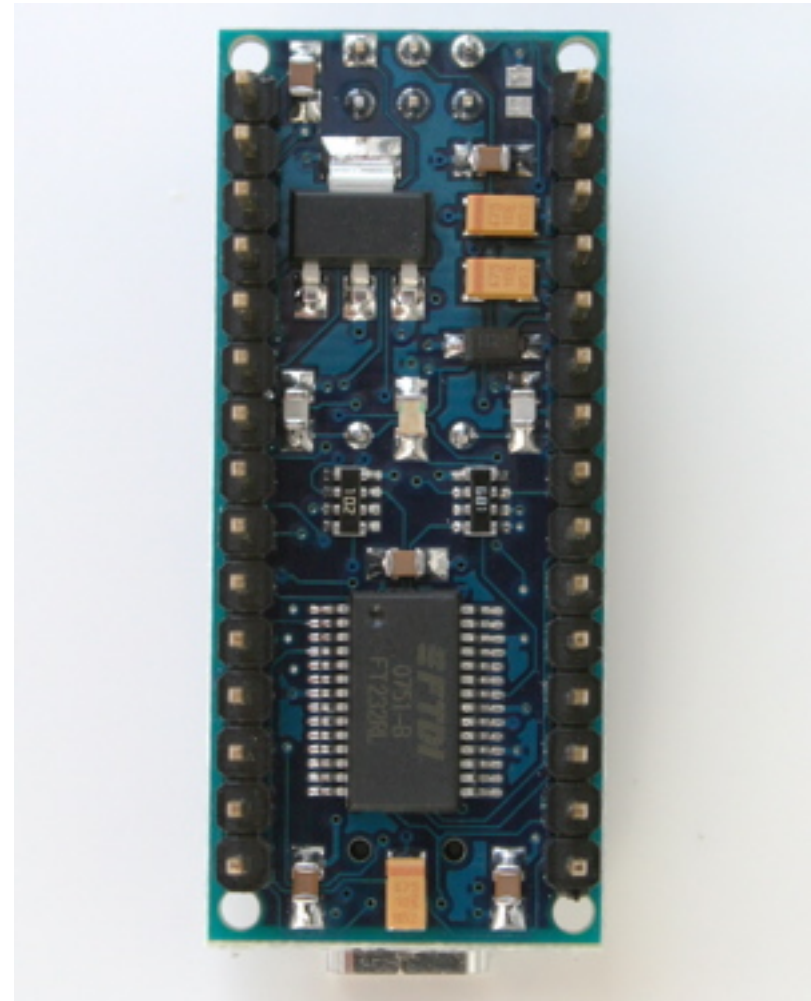
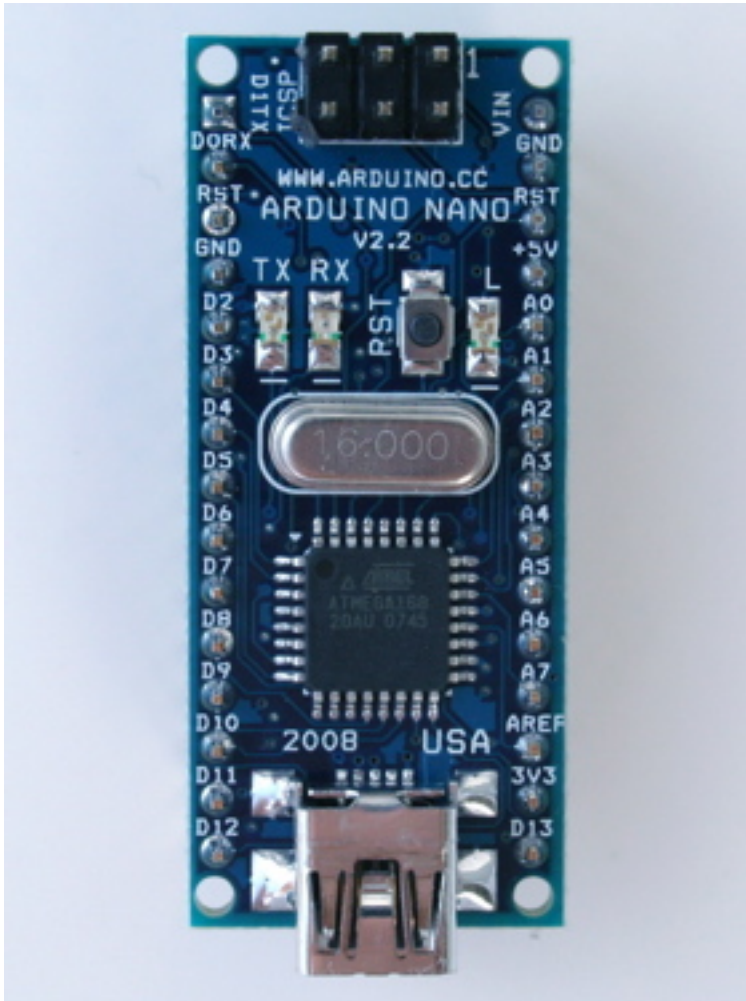

Arduino Mega

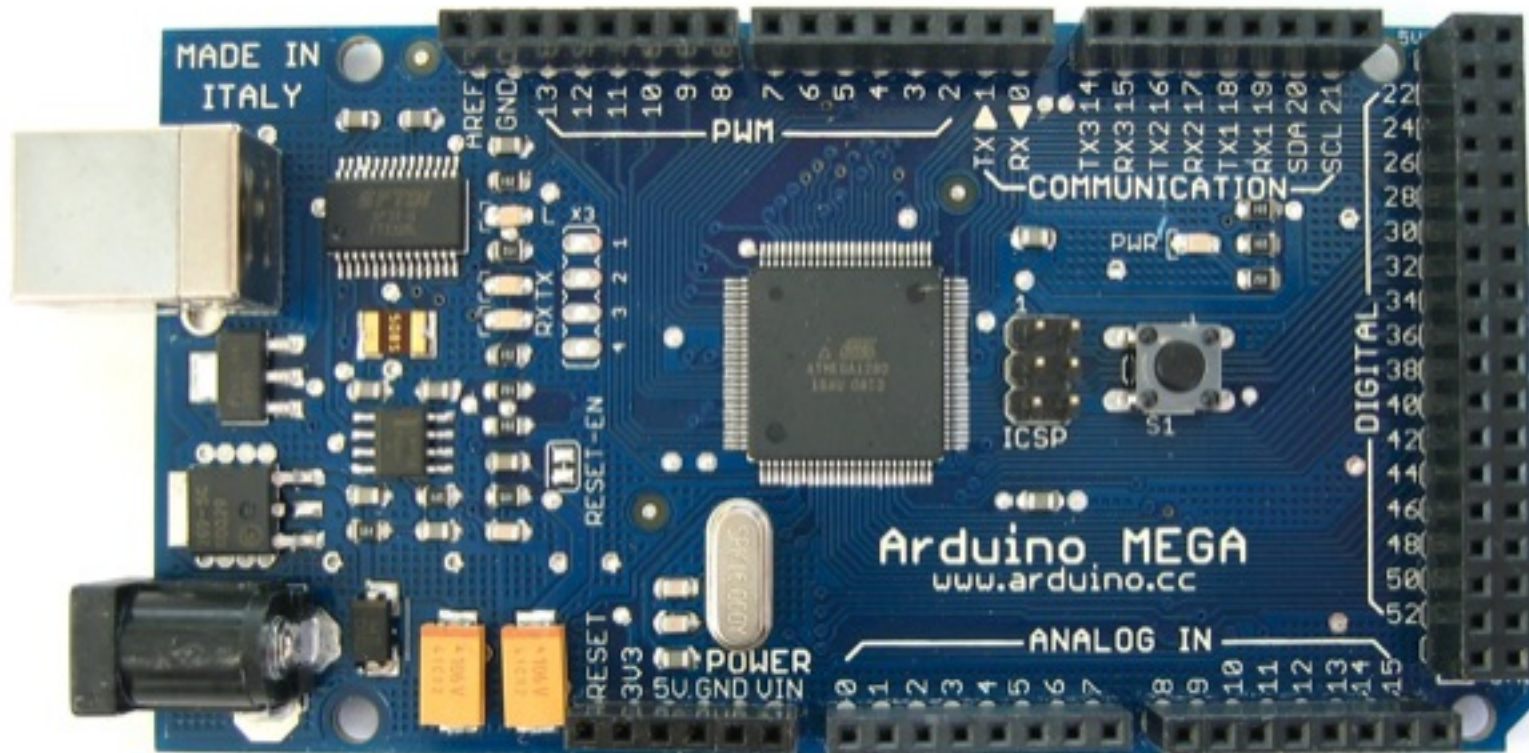

Arduino Bluetooth

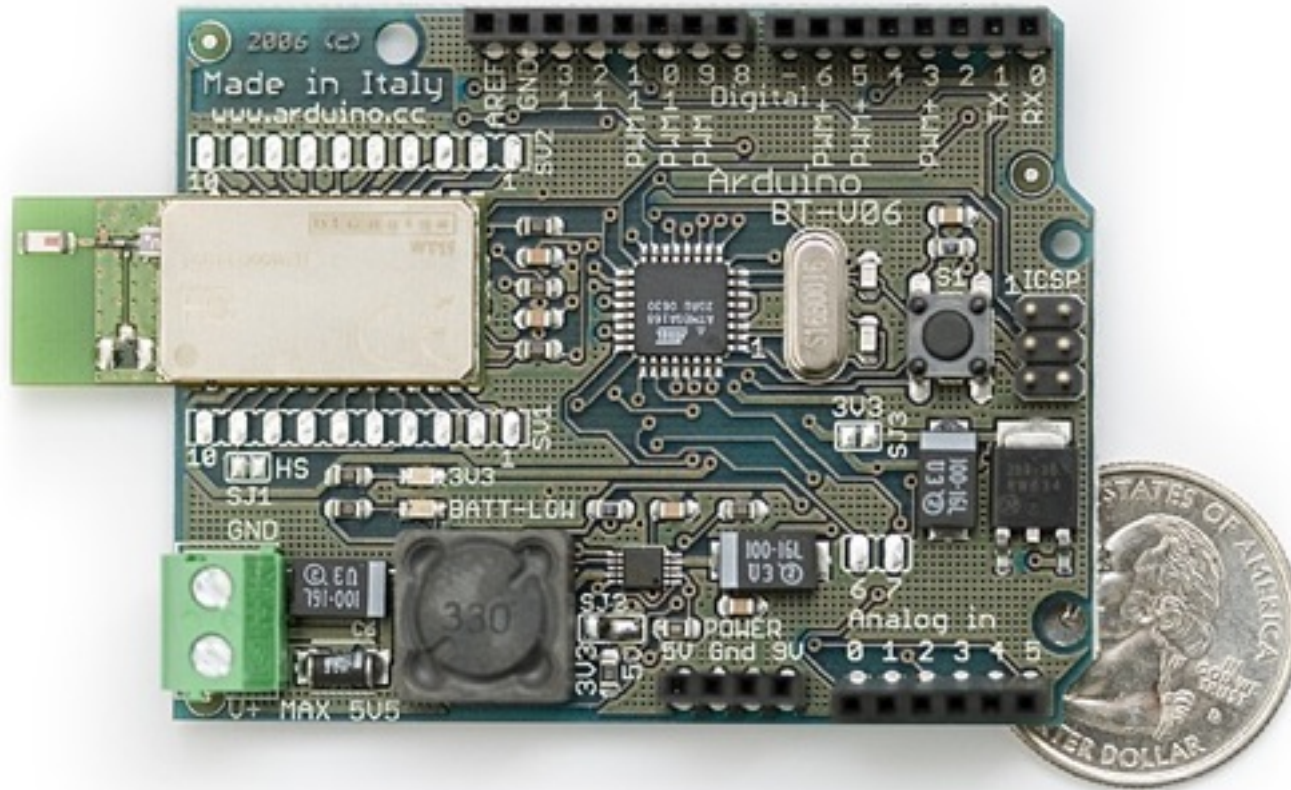

Arduino LilyPad

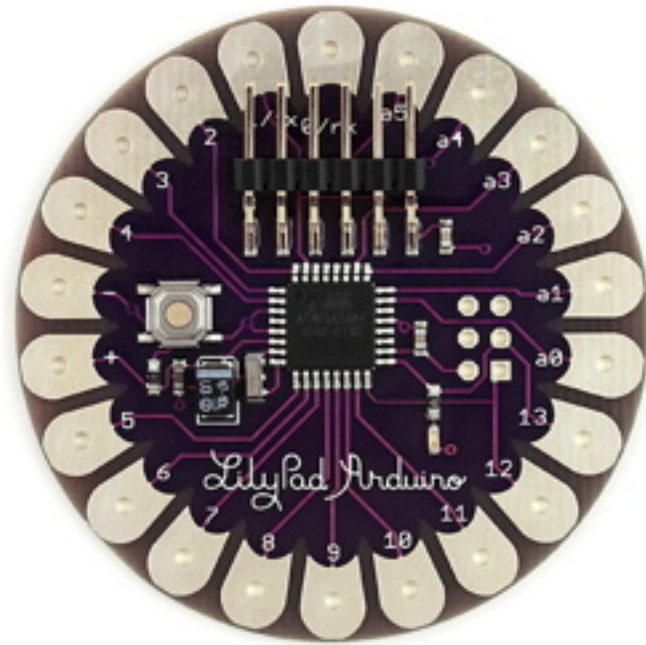

Arduino Mini

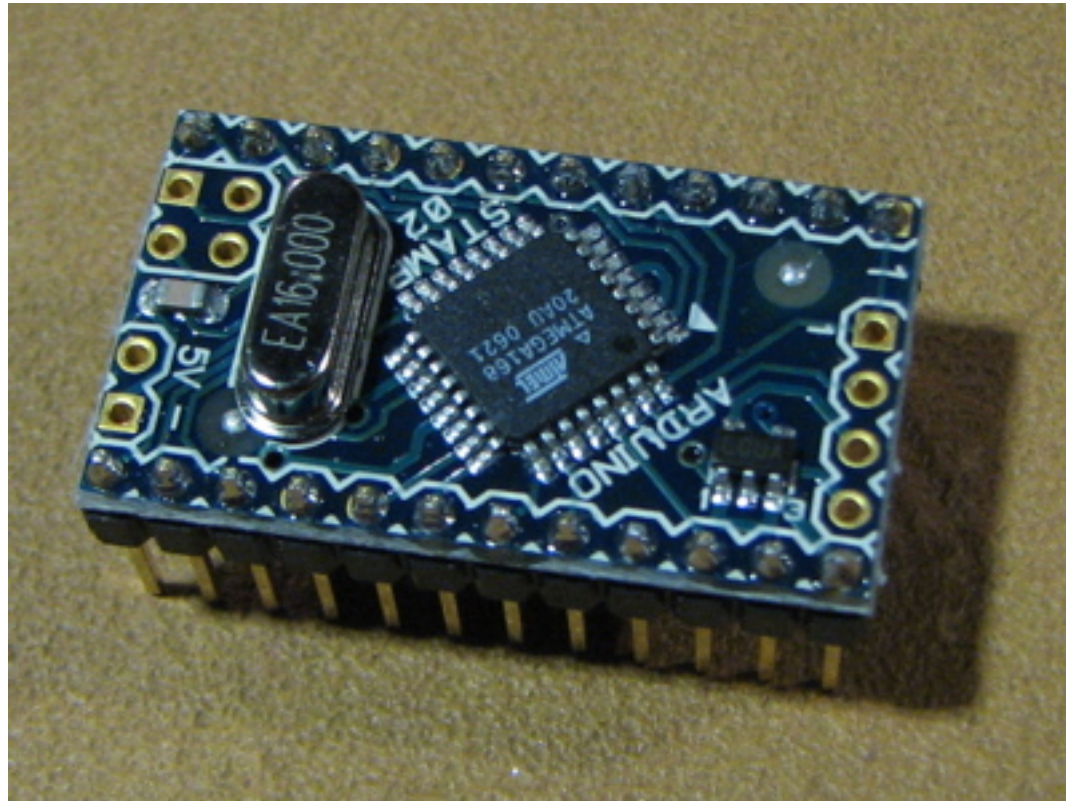

Arduino Mini USB Adapter

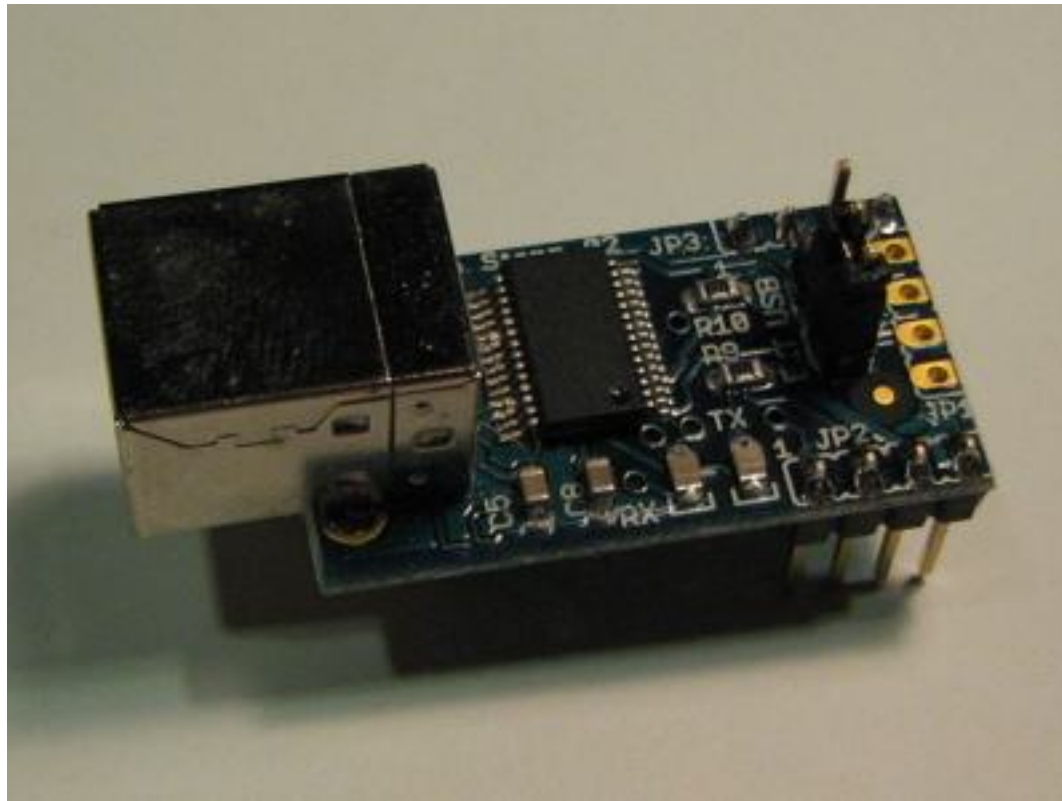

Arduino Pro

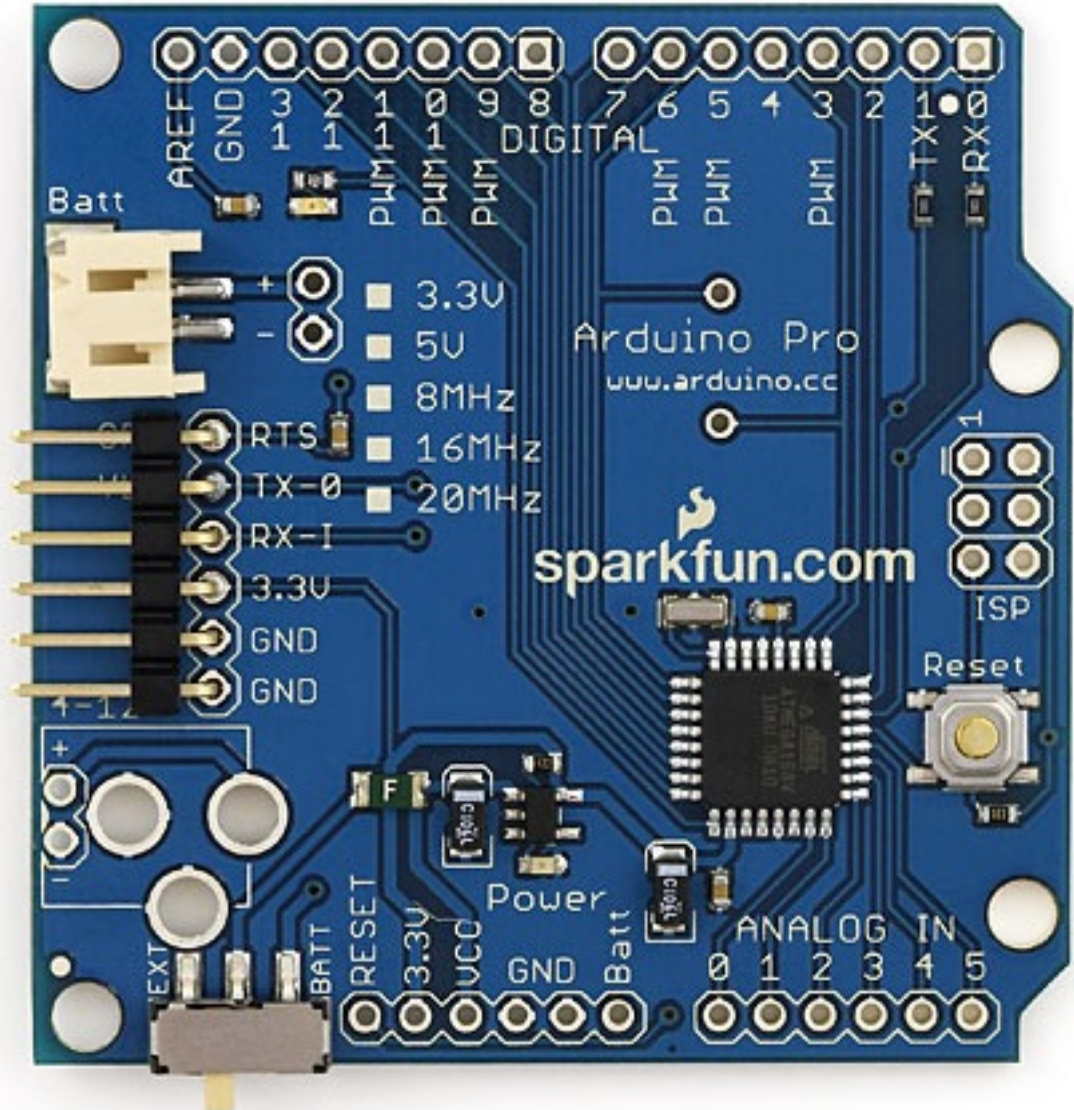

Arduino Pro Mini

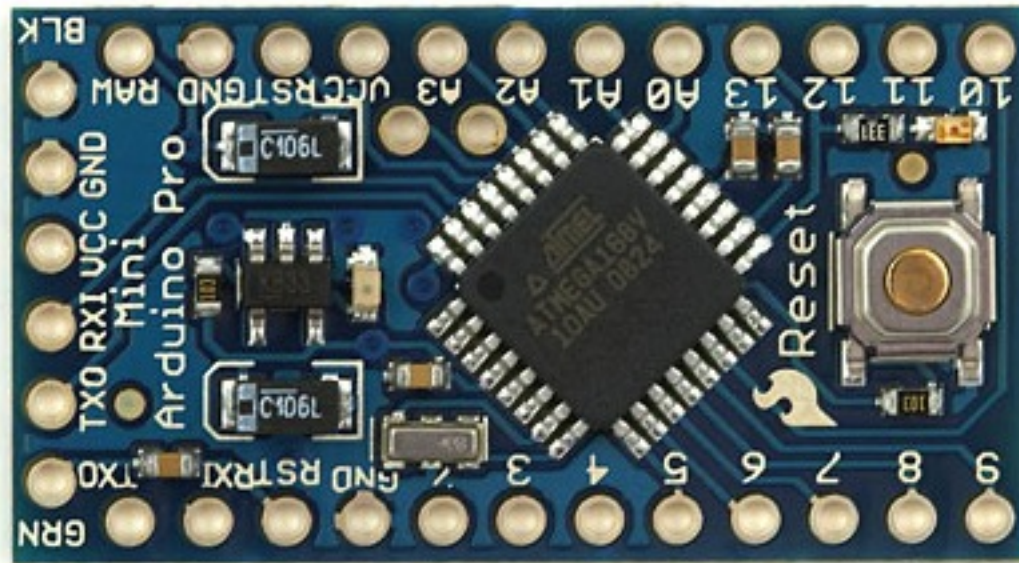

Arduino Serial

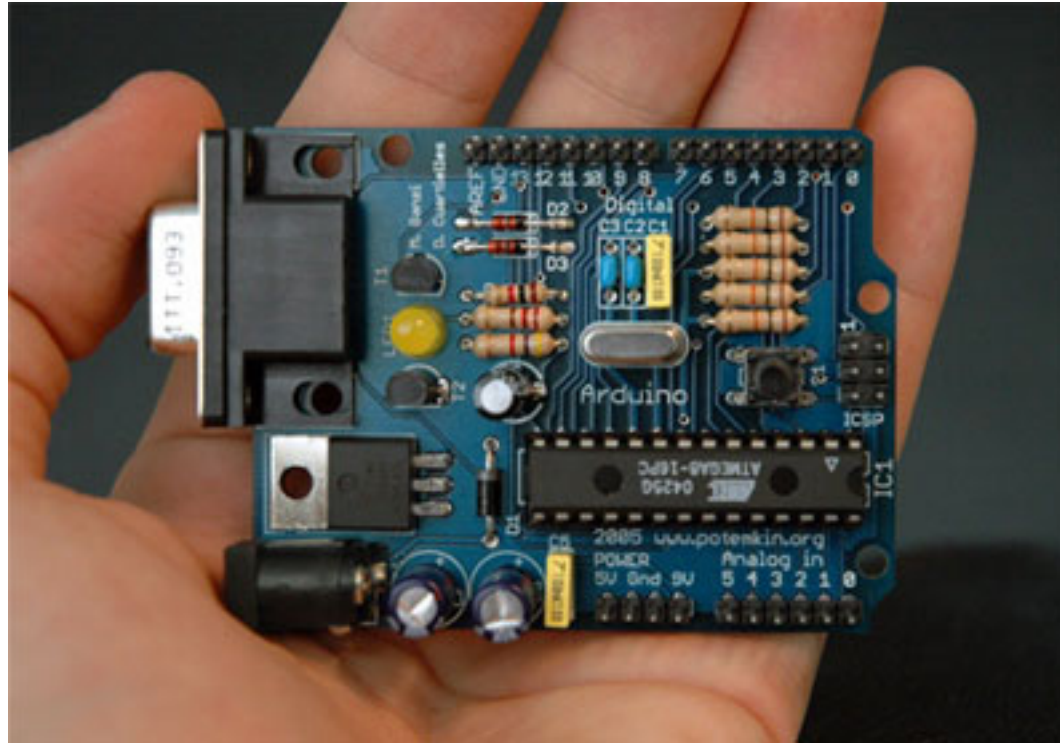

Arduino Serial Single Sided

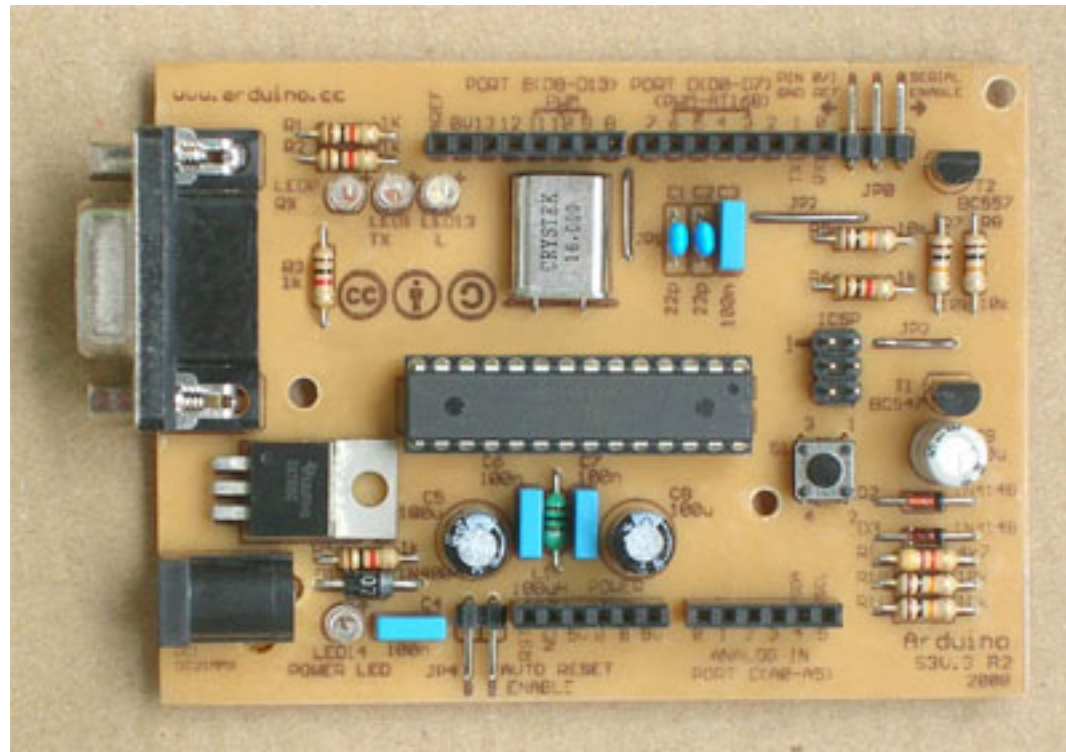

類Arduino或Arduino相容的I/O board

- Seeeduino
- Sanguino
- Pinguino
- funnel IO
- ...族繁不及備載, 請上網尋找! (這就是open source的樂趣啊!)

Seeeduino

http://www.seeedstudio.com/blog/?page_id=110

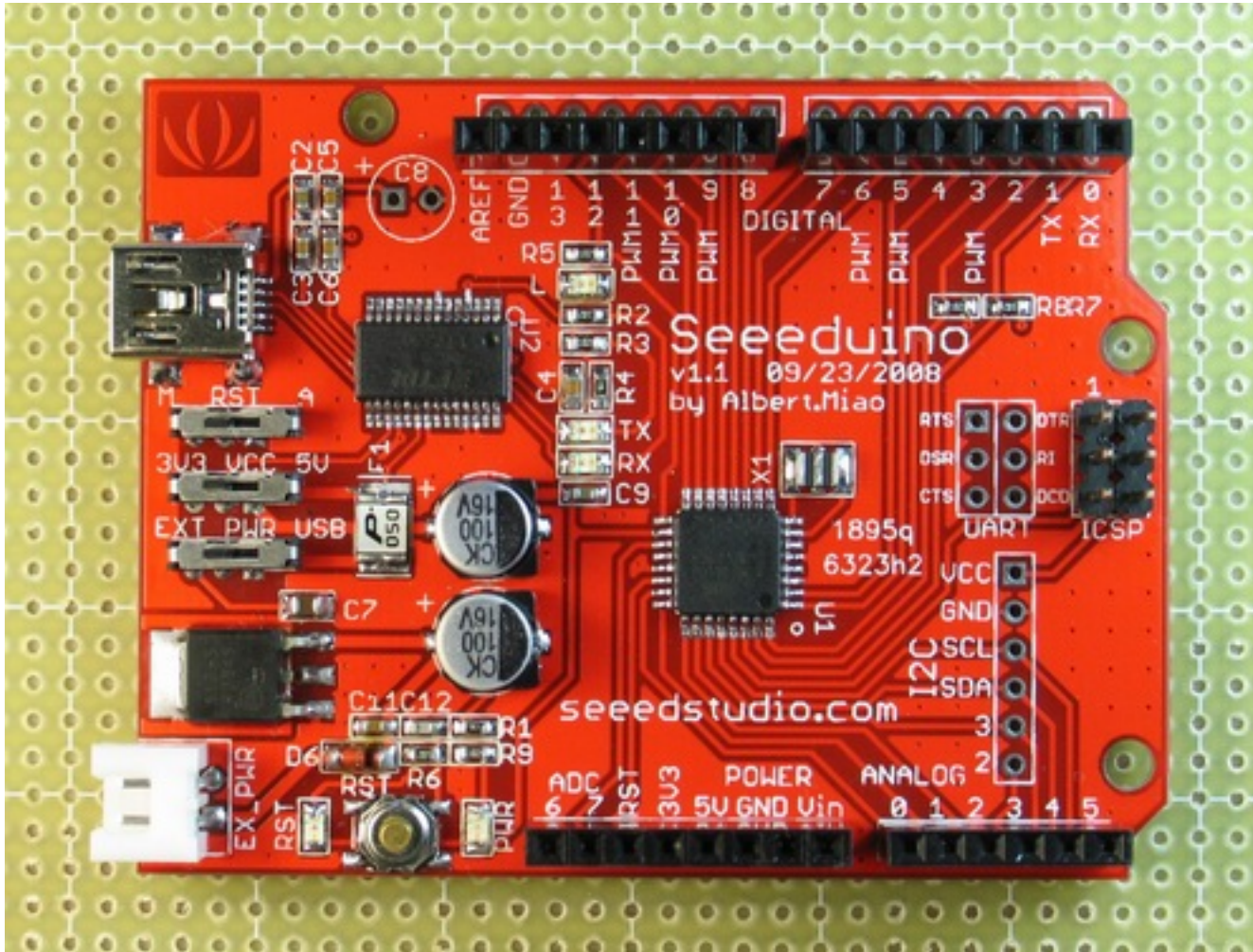

Sanguino

<http://sanguino.cc/>

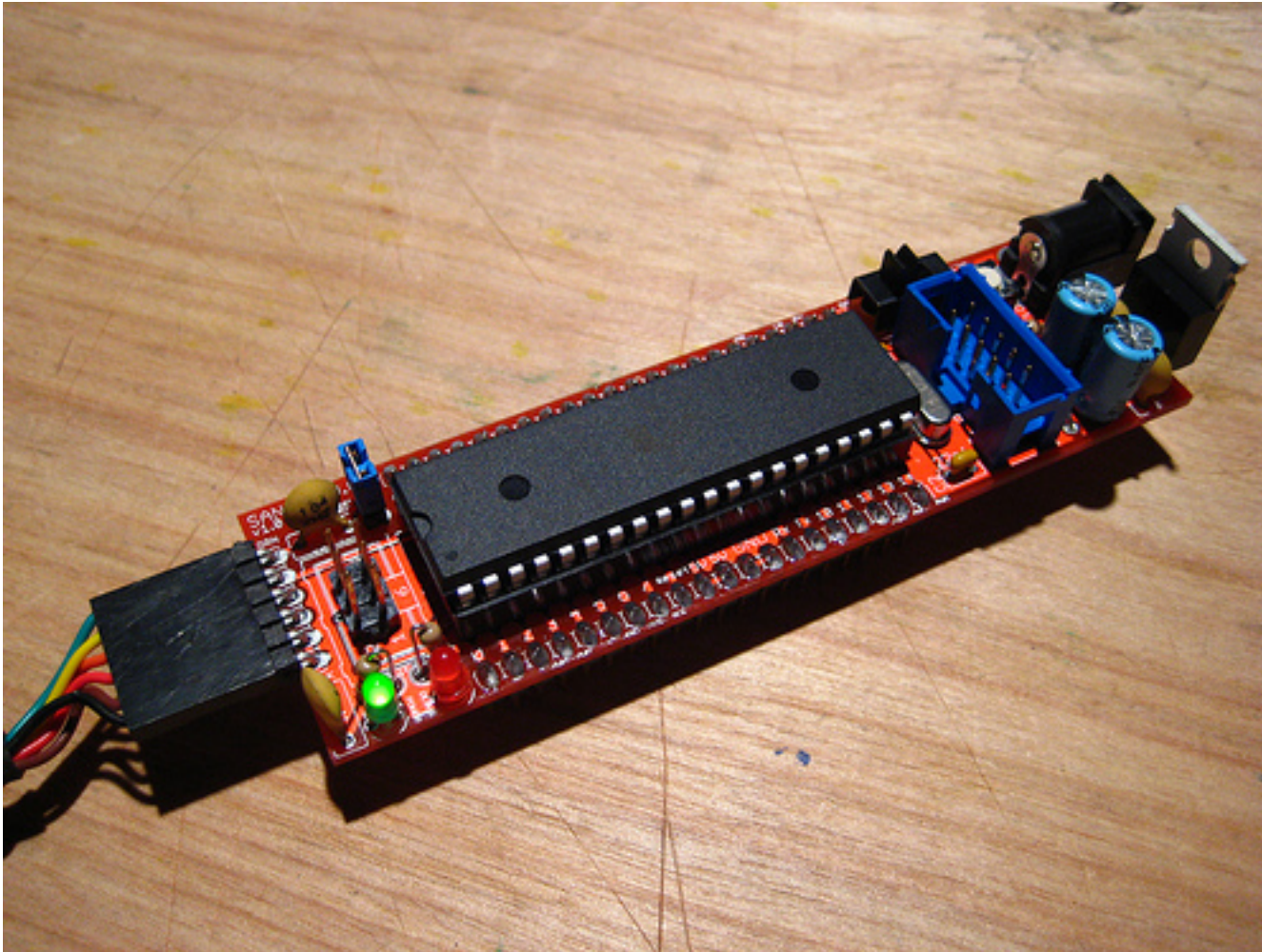

Pinguino

<http://www.hackinglab.org/pinguino/index.html>

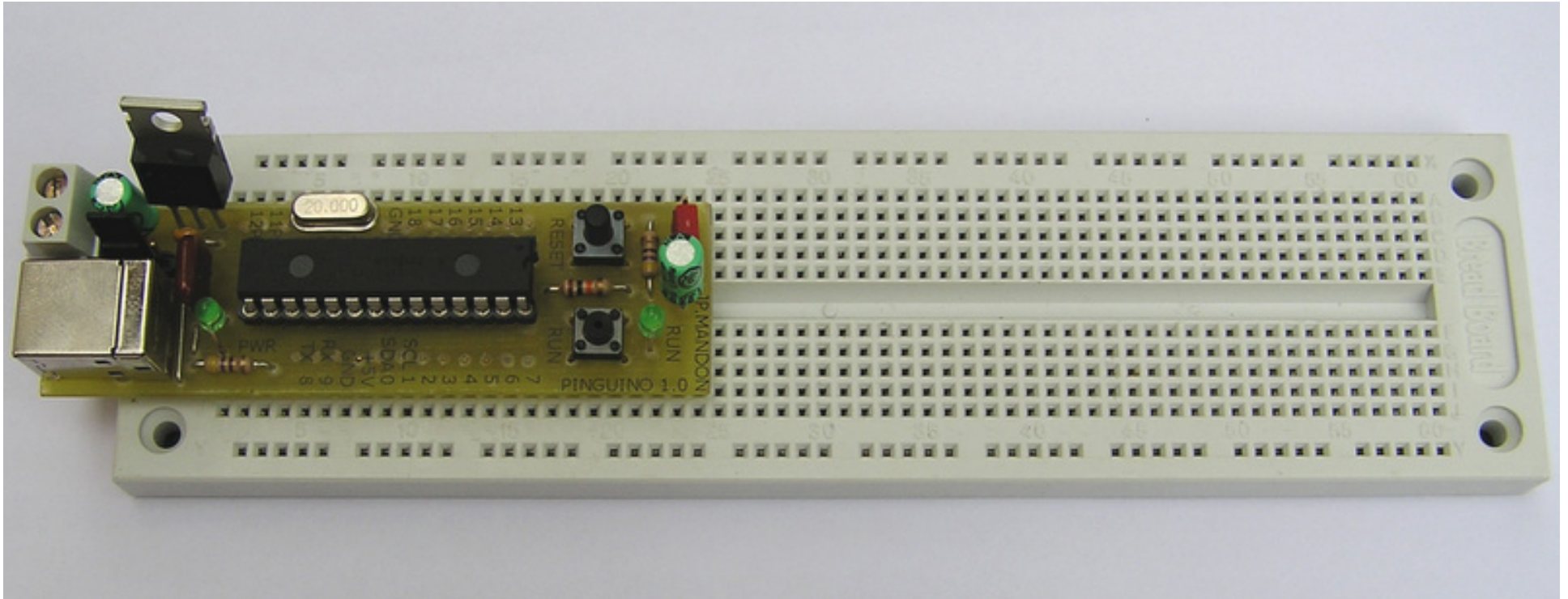

funnel IO

<http://funnel.cc/Main/HomePage>

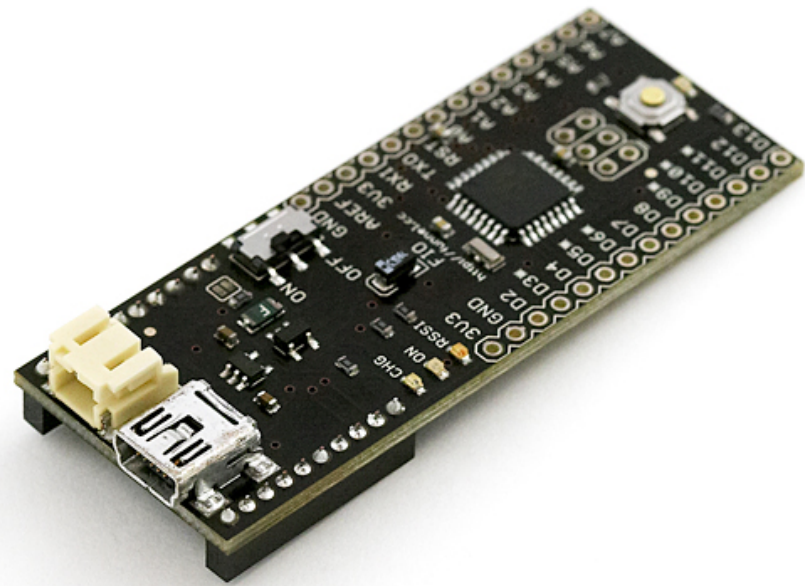

如何取得Arduino?

台灣代理商:



http://www.playrobot.com/home_index.htm



<http://www.aroboto.com/>

國外代理商:



<http://www.sparkfun.com/commerce/categories.php>

其他:

Arduino官網上列出全世界許多代理商

<http://arduino.cc/en/Main/Buy>

Lesson 1

Let's get start!

Lesson 1 - Let's get start!

- 事前準備
- 利用USB線將Arduino連接上電腦
- 了解Arduino I/O board
- 了解Arduino IDE
- 了解麵包板
- 最簡單的電路
- 範例一 Hello Arduino: blink LED!
- 範例二 LED loop
- 第二簡單的電路
- 範例三 Button

事前準備

1. 取得Arduino I/O board
2. 下載安裝Arduino IDE

<http://arduino.cc/en/Main/Software>

3. 安裝USB驅動程式(USB driver)

[Windows 使用者]

下載Arduino IDE後，利用USB將Arduino和PC相連接後，螢幕上會出現安裝驅動程式畫面。指定驅動程式安裝路徑(在arduino資料夾裡 -> [drivers] -> [FTDI USB Drivers])，連續安裝兩次即可。

[PowerPC Mac 使用者 (Powerbook, iBook, G4 or G5)]

下載Arduino IDE後，在arduino資料夾裡 -> [drivers] -> 執行FTDIUSBSerialDriver_v2_1_9.dmg安裝

[Intel Mac 使用者 (MacBook, MacBook Pro, or Mac Pro)]

下載Arduino IDE後，在arduino資料夾裡 -> [drivers] -> 執行FTDIUSBSerialDriver_v2_1_9.dmg安裝

利用USB線(A公-B公)將Arduino連接上電腦

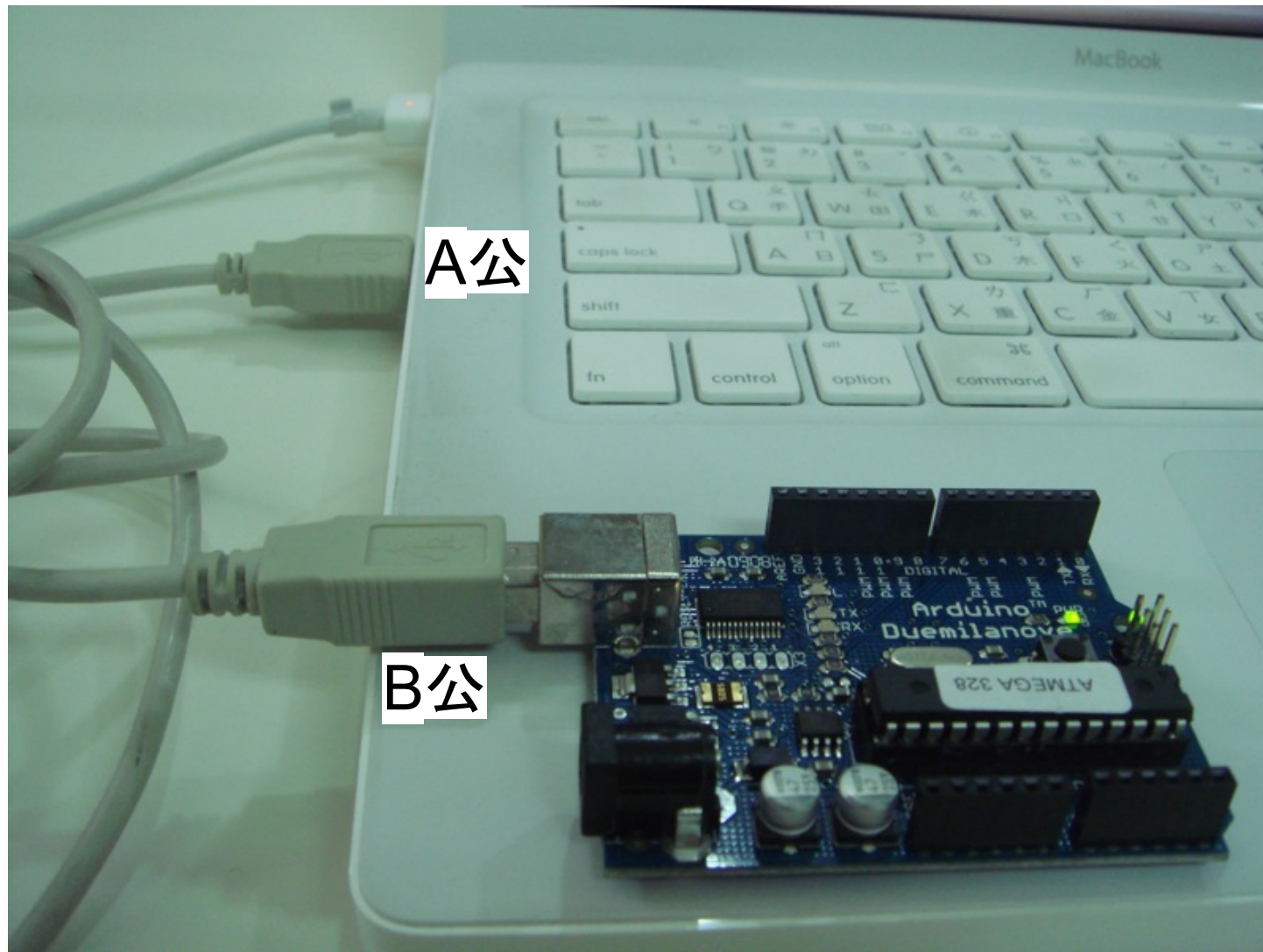

PS. Windows使用者此時若出現“發現新硬體”的視窗，一直點選下一步安裝USB驅動程式即可（請參考 Arduino 官網 <http://arduino.cc/en/Guide/Windows>）

了解Arduino I/O board

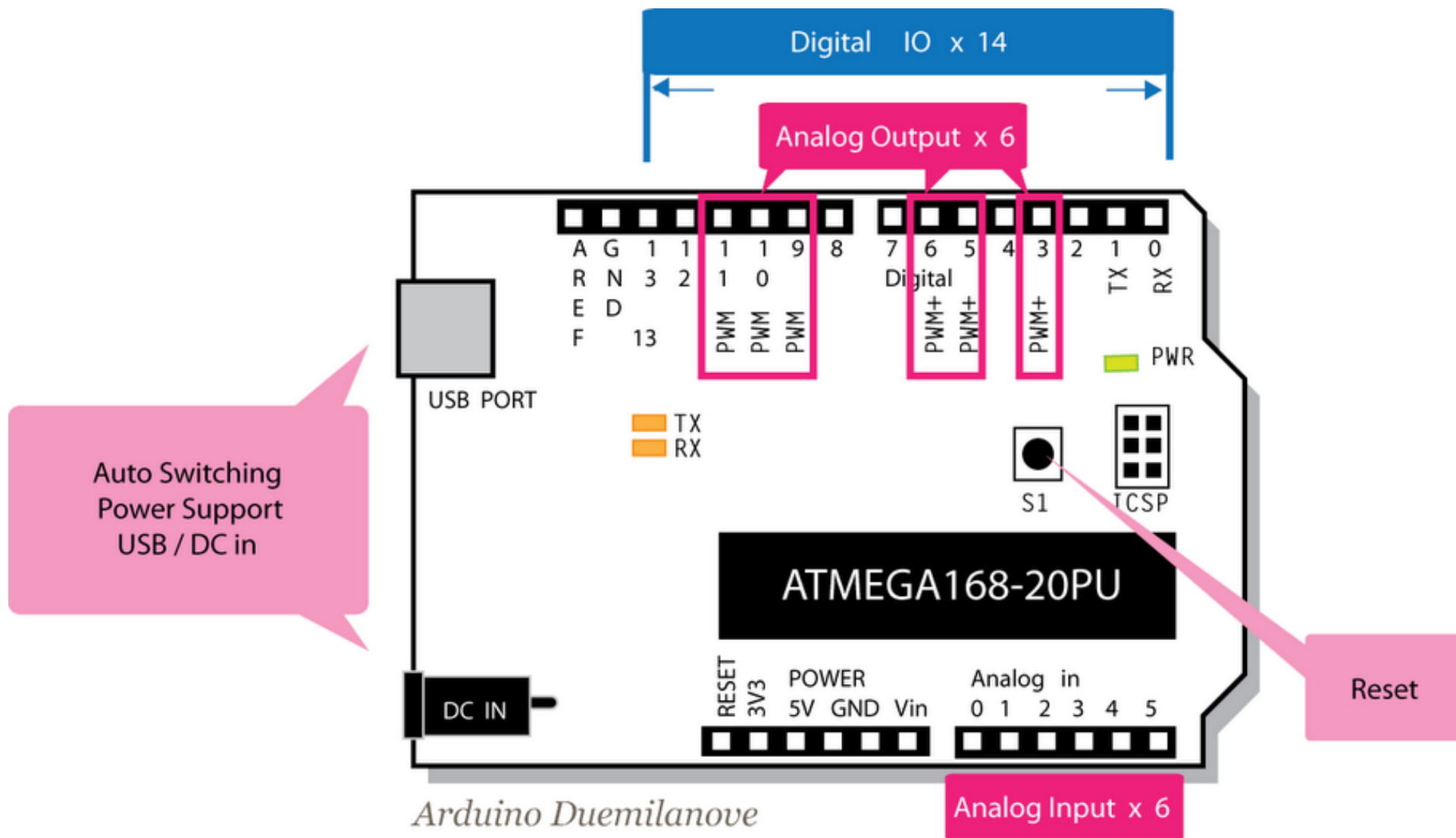

了解Arduino I/O board

| | |
|-------------|---|
| Digital I/O | 共13，數位輸出/輸入端(pin 13作為LED指示用) |
| Analog Out | 共6，在Digital I/O中的pin 3,5,6,9,10,11 可做類比輸出使用 |
| Analog In | 共6，類比輸入端pin 0~5 |
| Tx/Rx | 支援Tx/Rx訊號輸入輸出（若使用時，Digital I/O pin 0,1不可作為數位輸出入/使用） |
| USB傳輸與供電 | 支援USB直接供電，以及USB接頭資料傳輸 |
| 輸入電壓 | 可選擇USB直接供電或外部供電(建議7V~12V)，用JUMP切換 (Duemilanove版本改用自動切換) |
| 輸出電壓 | 有5V、3.3V與Vin三種電壓輸出 |
| 支援線上燒錄功能 | 免去燒入經片需要重複拔插晶片的痛苦 |
| LED 13 | pin 13內建一個LED |

p.s.

- (1) 當Digital I/O不敷使用時，可用Analog In pin另外代用，宣告為pin 14~19
- (2) 一般不建議使用Digital I/O pin 0,1，因為常作為Serial port傳輸用

資料來源：<http://interactive2go.blogspot.com/2009/04/get-to-start.html>

了解Arduino IDE

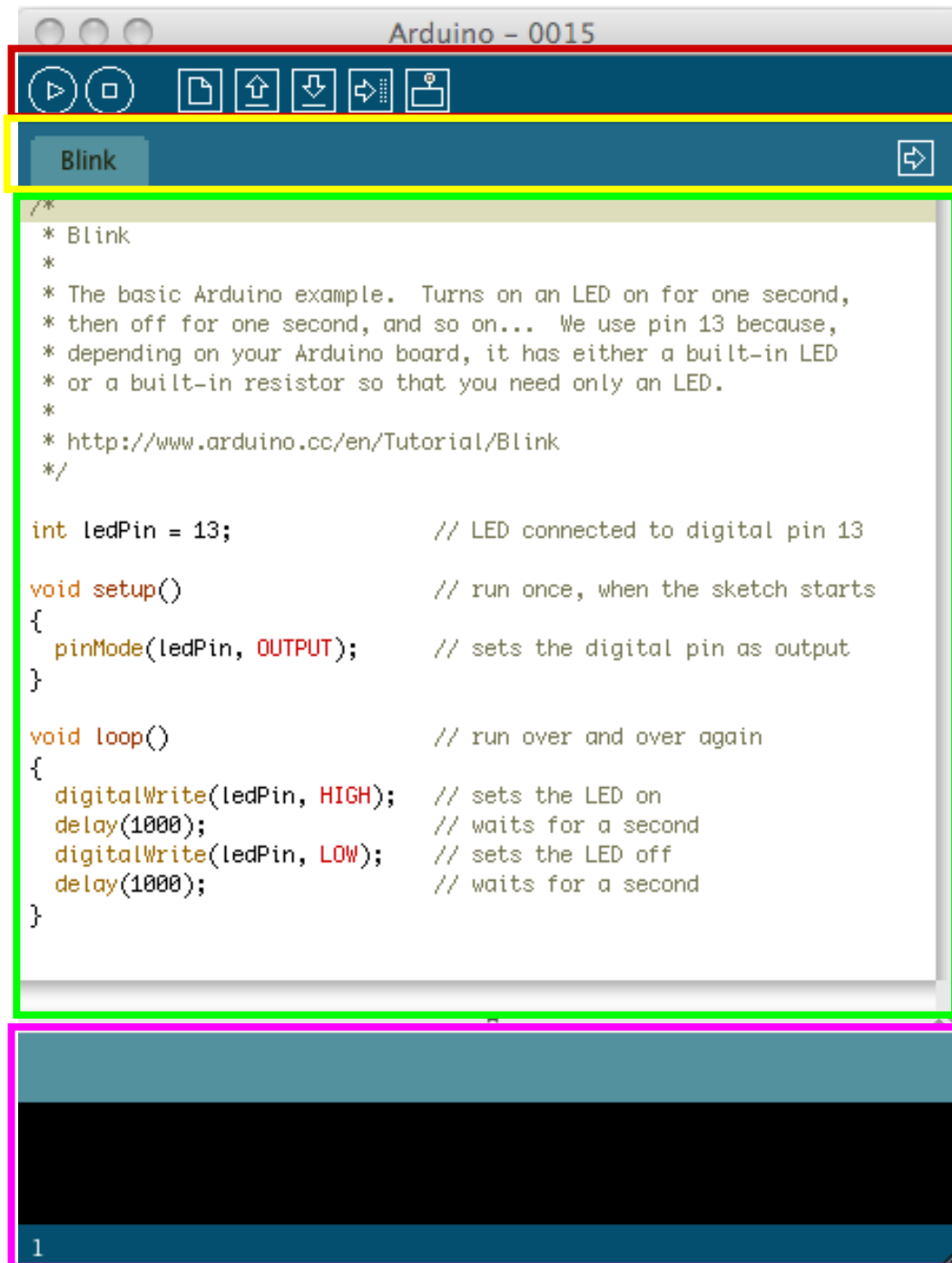

工具列

程式碼分頁

程式內容

訊息顯示區

了解麵包板

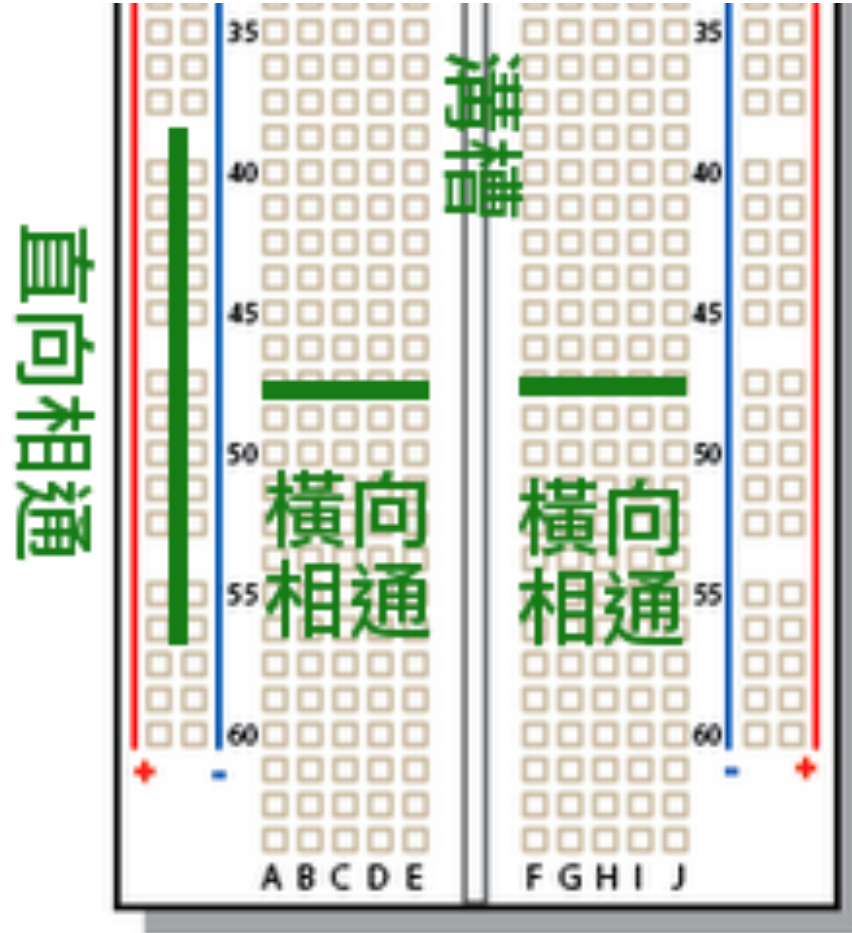

最簡單的電路

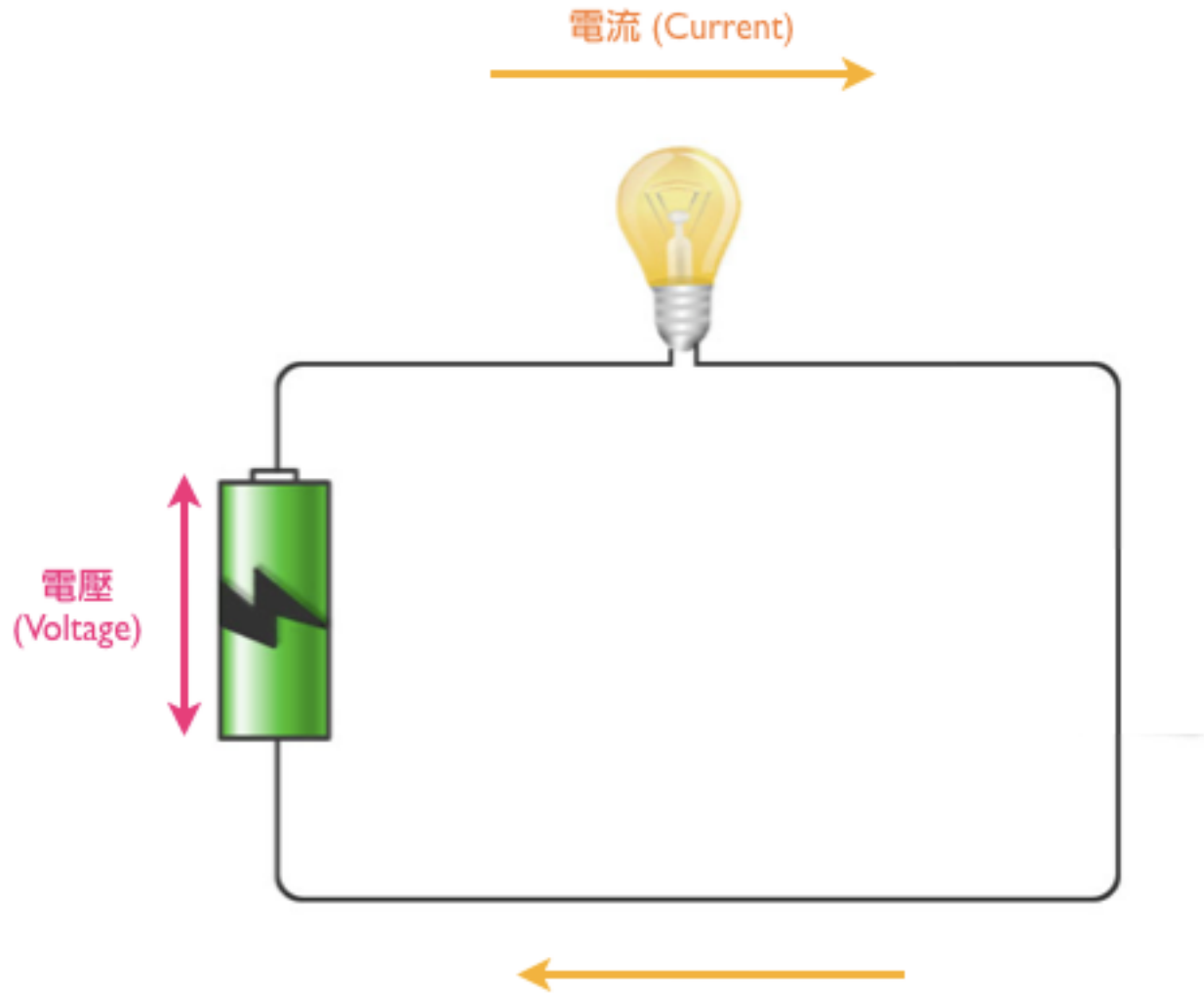

圖片來源：<http://interactive2go.blogspot.com/2009/04/digital-out.html>

最簡單的電路 (加上電阻)

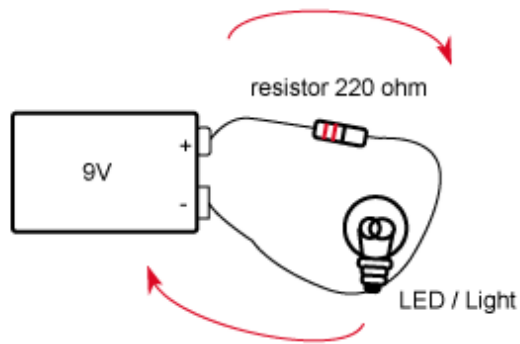

線路示意圖

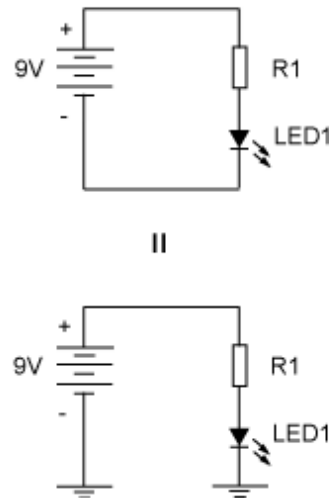

電路圖

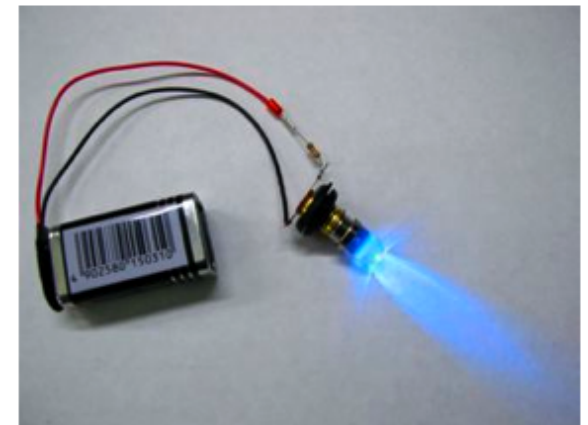

實作此電路

範例一 Hello Arduino: blink LED!

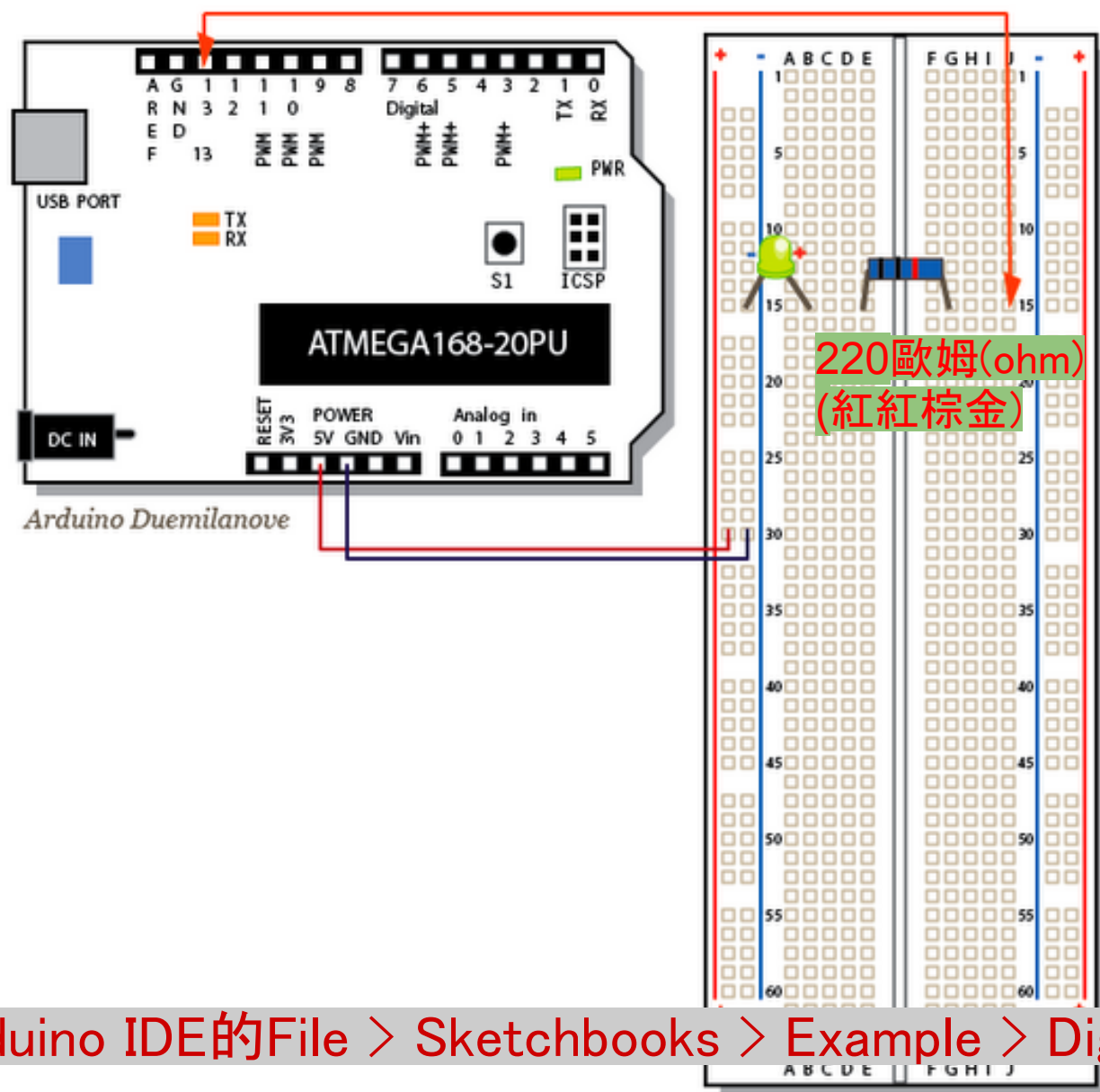

程式檔: Arduino IDE 的 File > Sketchbooks > Example > Digital > Blink

圖片來源: <http://interactive2go.blogspot.com/2009/04/digital-out.html>

上傳程式至Arduino板子

1. 撰寫Arduino程式

2. 檢查程式是否有誤



3. 設定Arduino板子型號:

Tools > Board > Arduino Duemilanove w/ ATmega328

4. 設定USB serial port:

Tools > Serial Port > (windows跟mac不同)

Windows用戶請參考: <http://arduino.cc/en/Guide/Windows>

Mac用戶請參考: <http://arduino.cc/en/Guide/MacOSX>

5. 上傳程式至Arduino板子



範例一 Hello Arduino: blink LED!

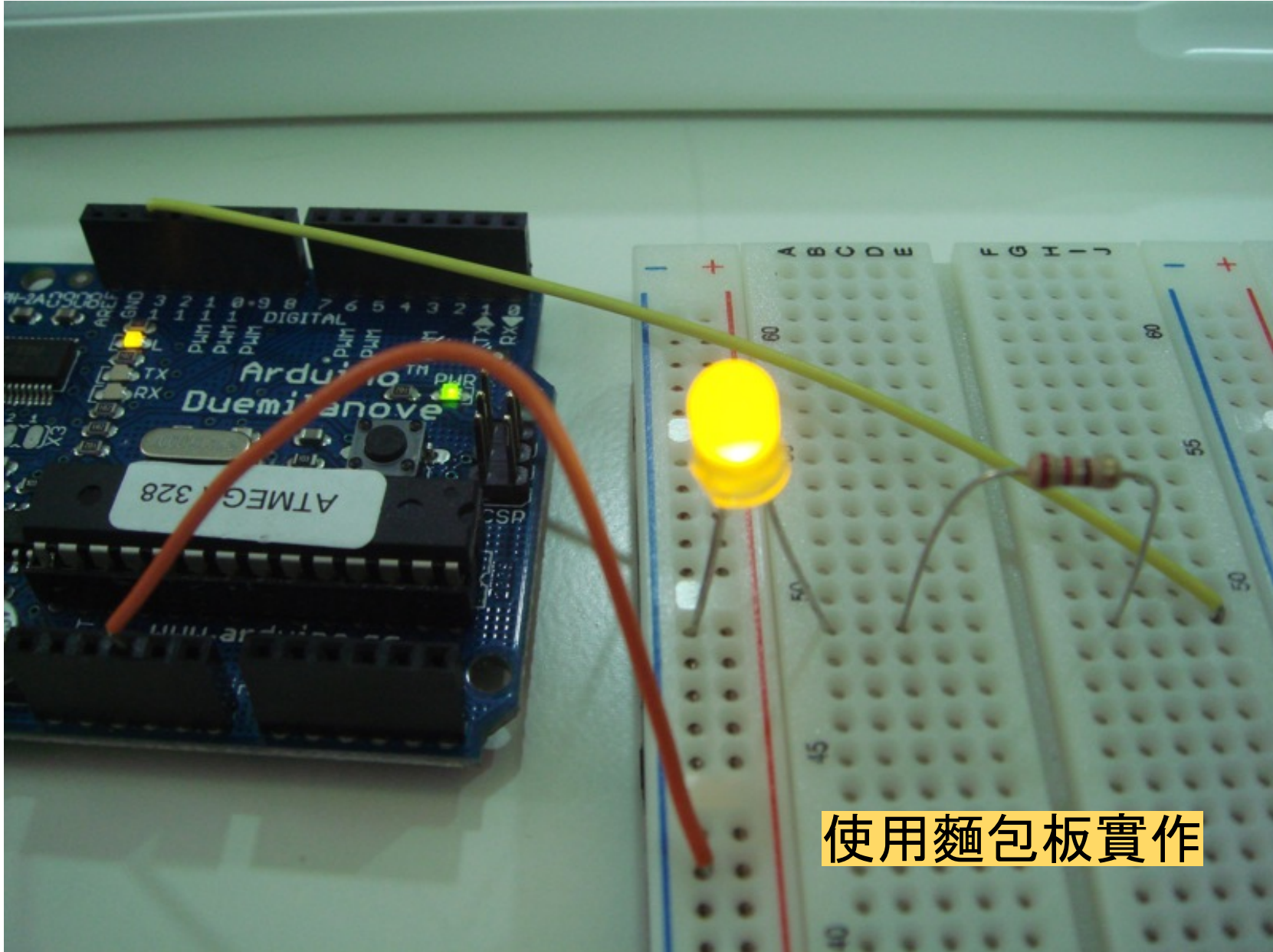

使用麵包板實作

範例一 Hello Arduino: blink LED!

使用Arduino板子上的pin 13跟GND實作
(Arduino板子已內建電阻)

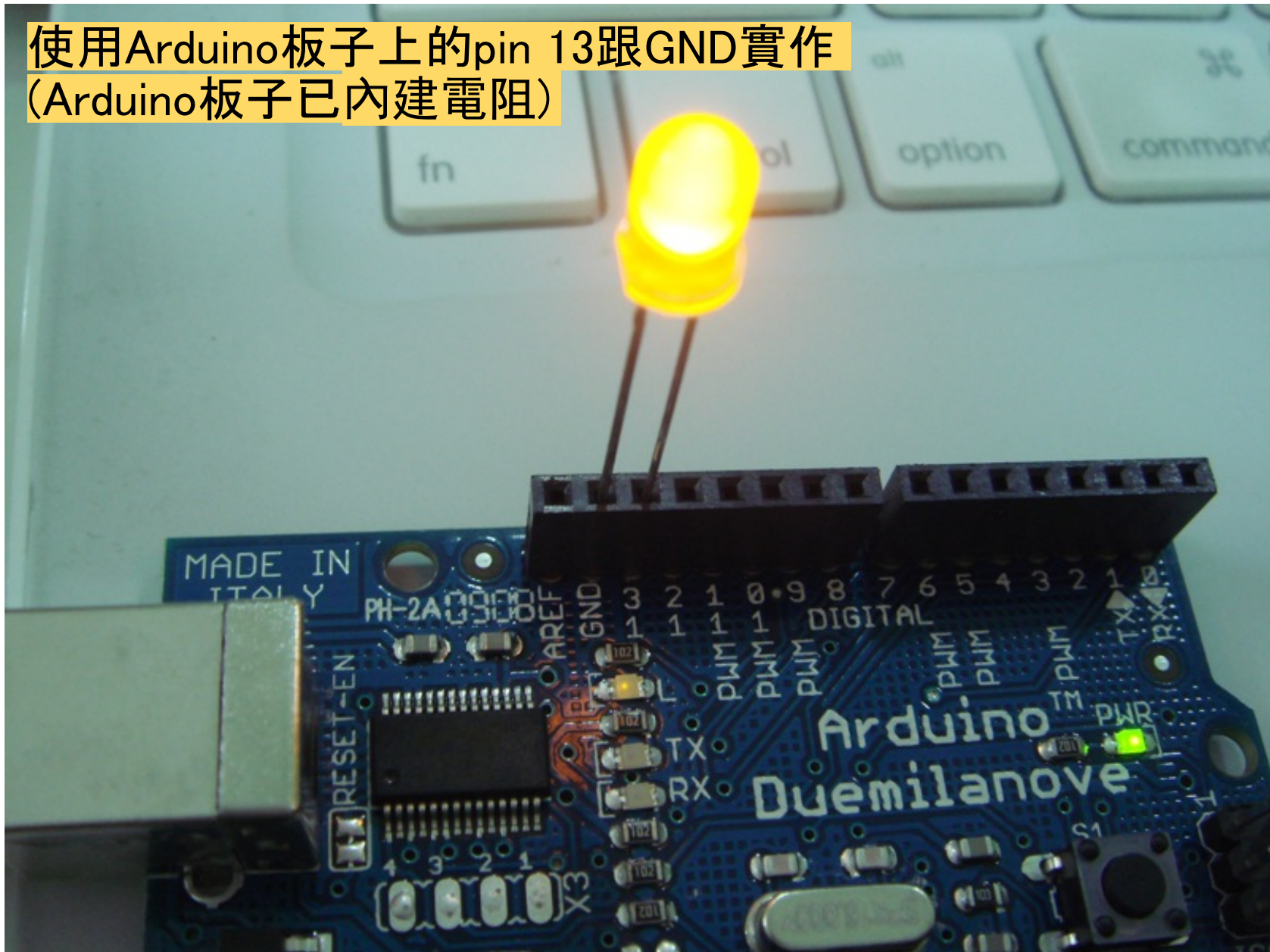

範例一 Hello Arduino: blink LED!

Duemilanove、Diecimila and LilyPad
已內建接在pin 13的LED燈



Blink程式碼解說

```
void setup()           //初始設定區塊 (只執行一次)
{
}

void loop()            //重複執行區塊 (不斷地重複執行)
{

}
}
```

Blink程式碼解說

```
int ledPin = 13;
```

```
//設定第13pin為接LED燈的pin腳
```

```
void setup()
```

```
{
```

```
}
```

```
void loop()
```

```
{
```

```
}
```

Blink程式碼解說

```
int ledPin = 13;
```

//設定第13pin為接LED燈的pin腳

```
void setup()
```

```
{
```

```
  pinMode(ledPin, OUTPUT); //設定pin腳模式為輸出
```

```
}
```

```
void loop()
```

```
{
```

```
  digitalWrite(ledPin, HIGH); //給pin腳高電壓 (LED通電就亮)
```

```
  delay(1000); //延遲1秒鐘(1000毫秒)
```

```
  digitalWrite(ledPin, LOW); //給pin腳低電壓 (LED不通電就暗)
```

```
  delay(1000); //延遲1秒鐘(1000毫秒)
```

```
}
```

範例二 LED loop

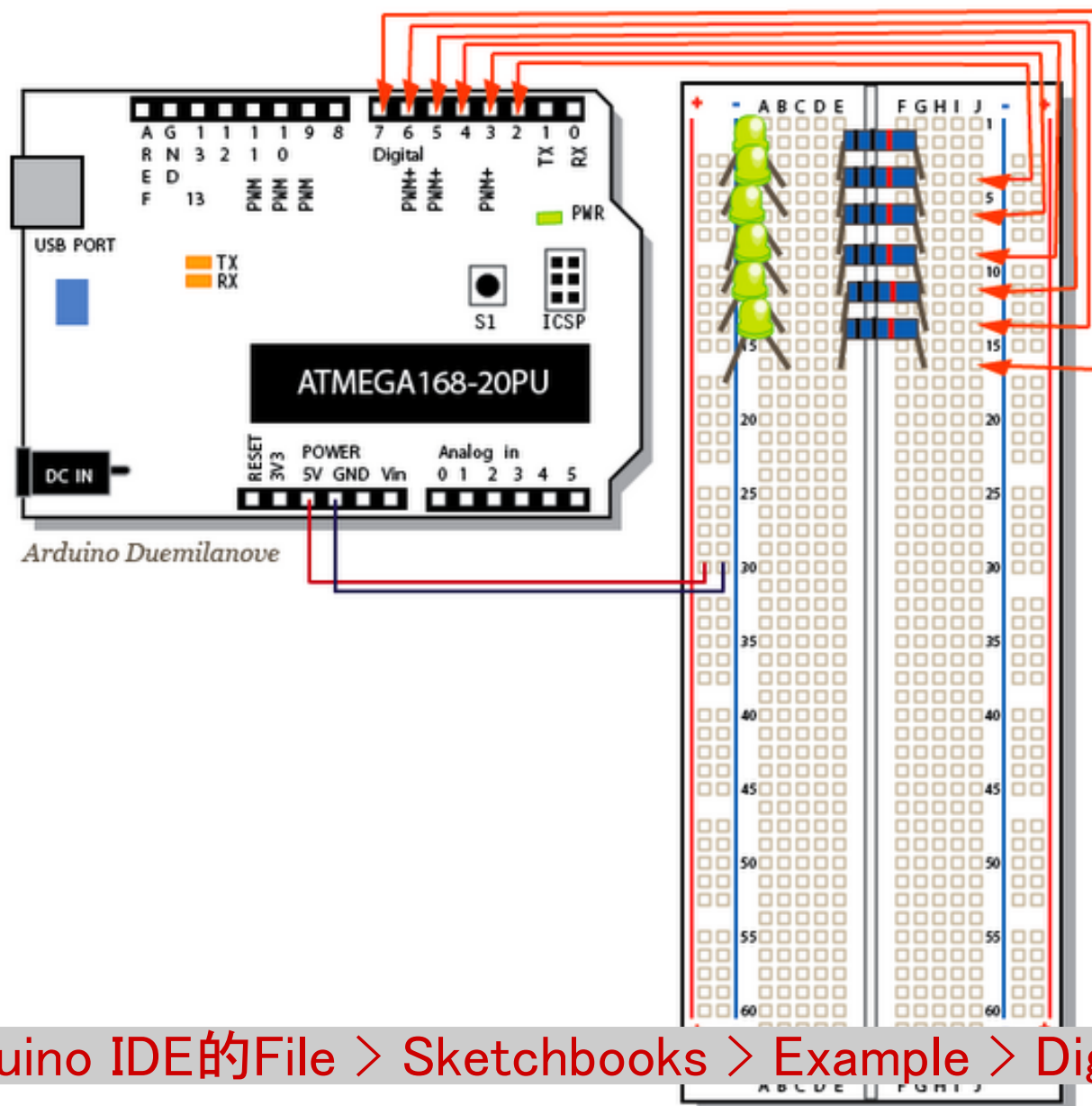

程式檔: Arduino IDE的File > Sketchbooks > Example > Digital > Loop

圖片來源: <http://interactive2go.blogspot.com/2009/04/digital-out.html>

範例二 LED loop

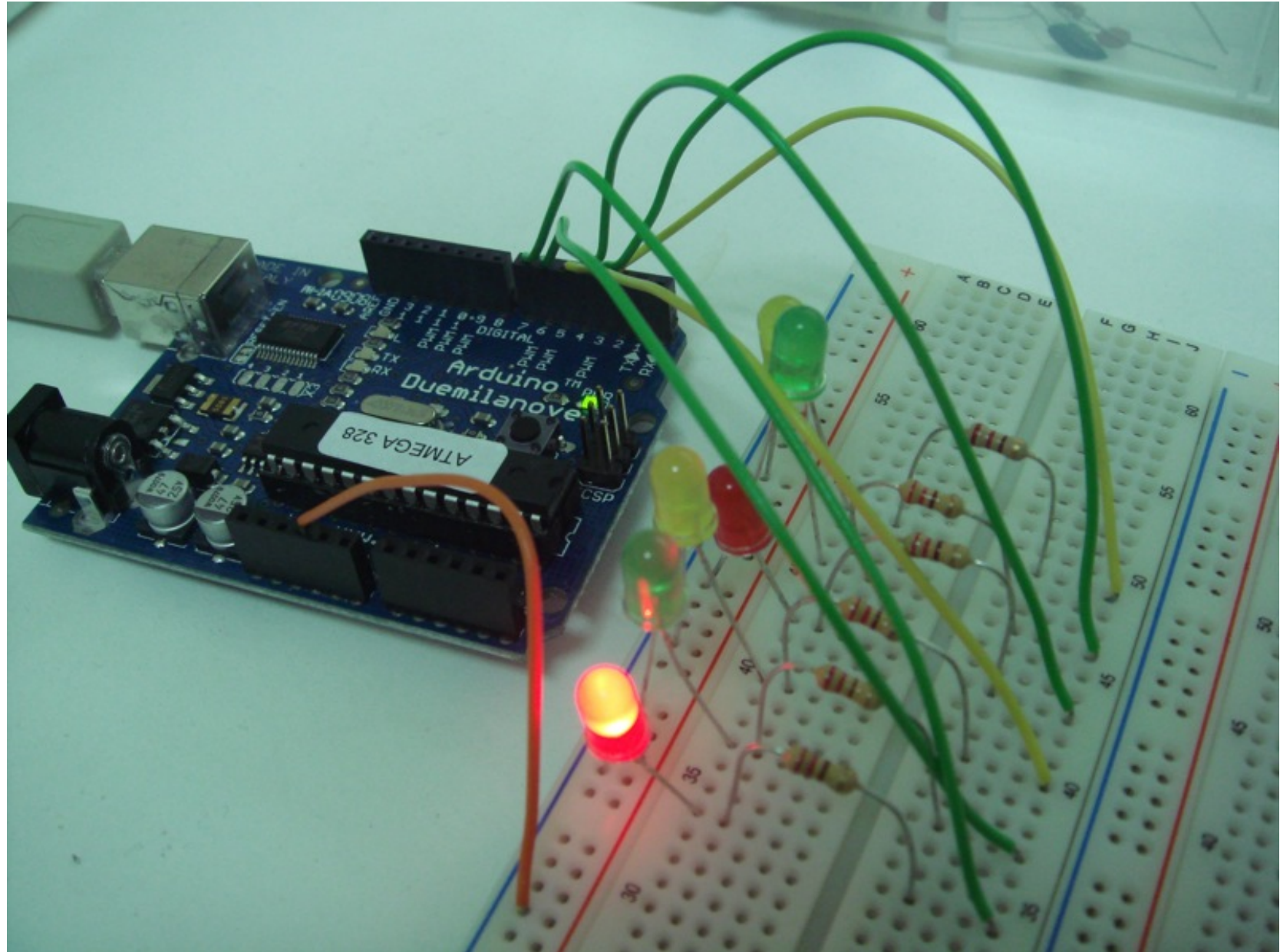

範例二 LED loop

影片來源: <http://www.youtube.com/watch?v=2q2jiePq6Ww>

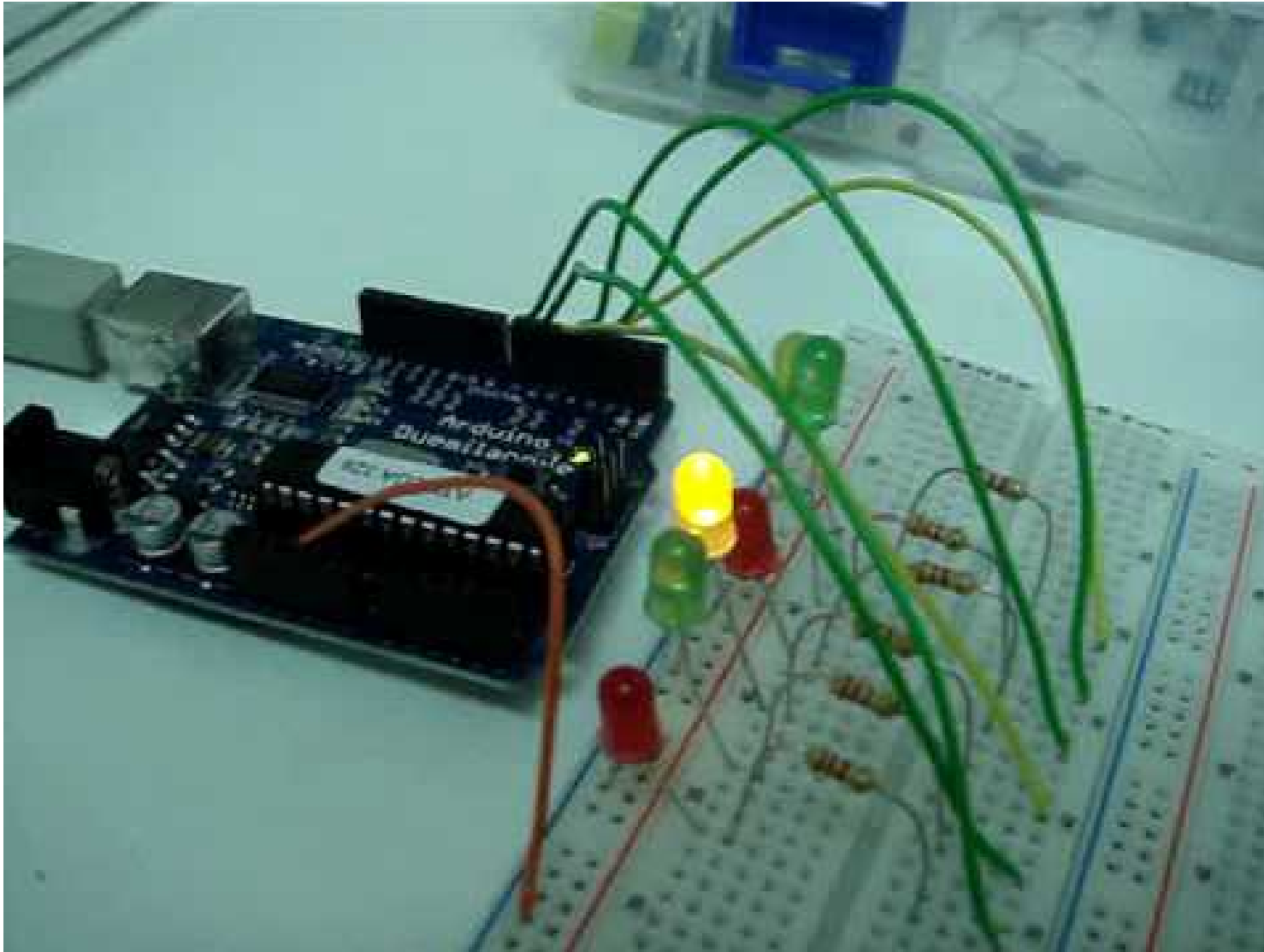

第二簡單的電路 (加上開關)

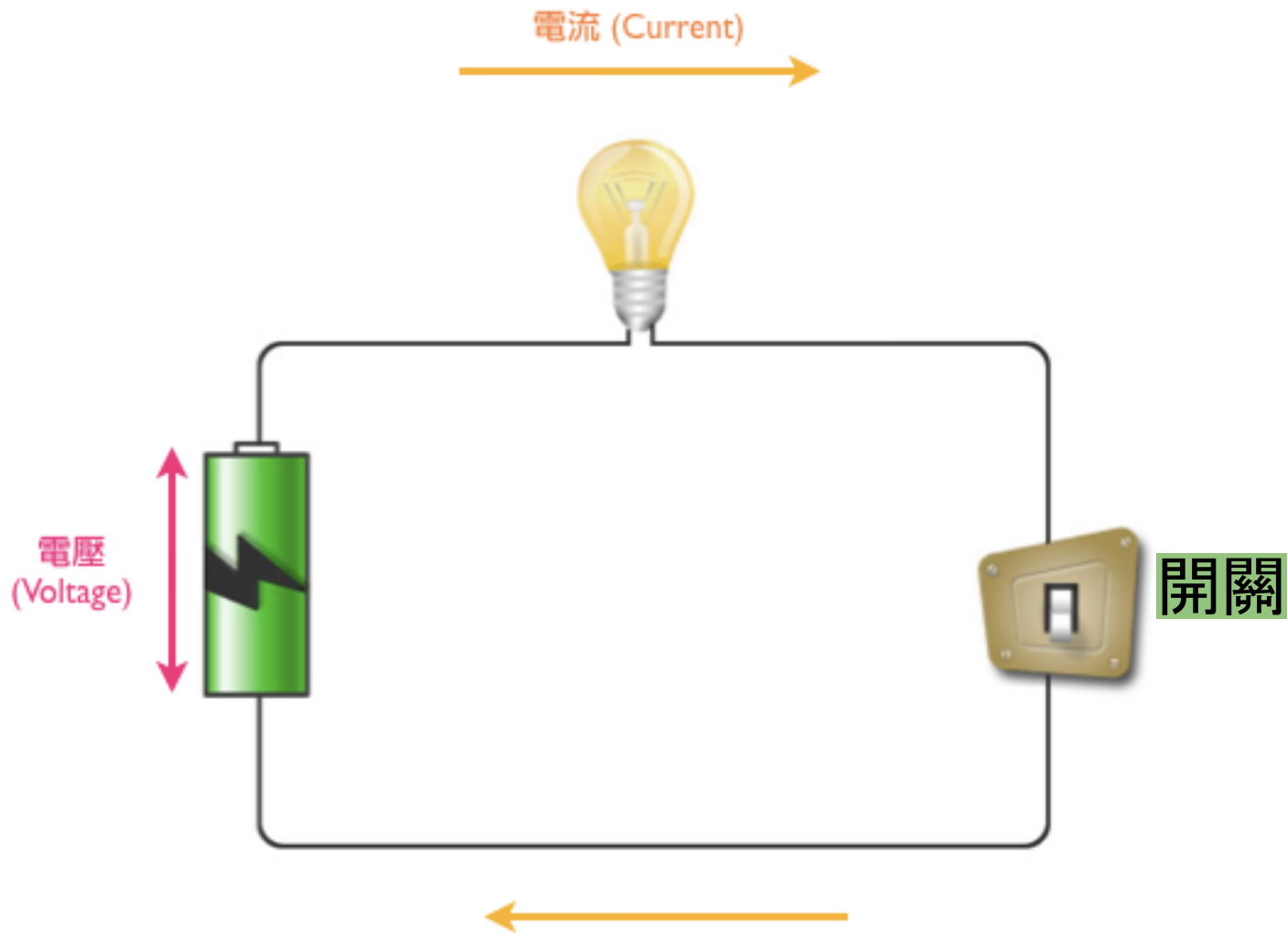

圖片來源：<http://interactive2go.blogspot.com/2009/04/digital-out.html>

範例三 Button (接法一)

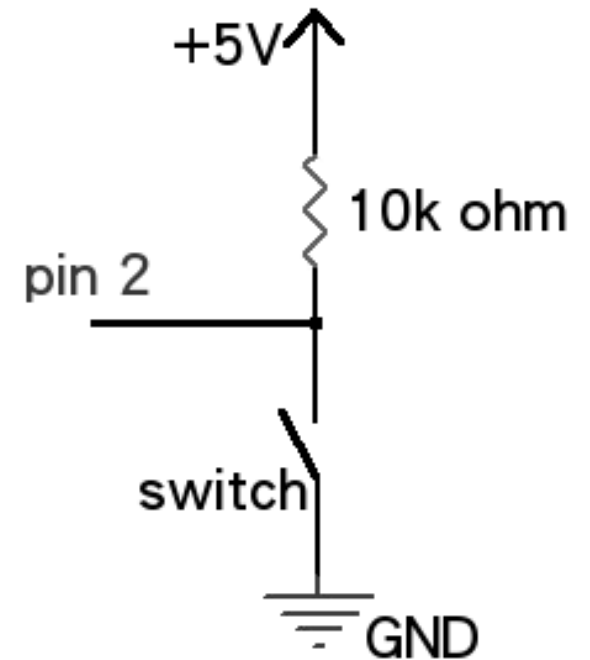
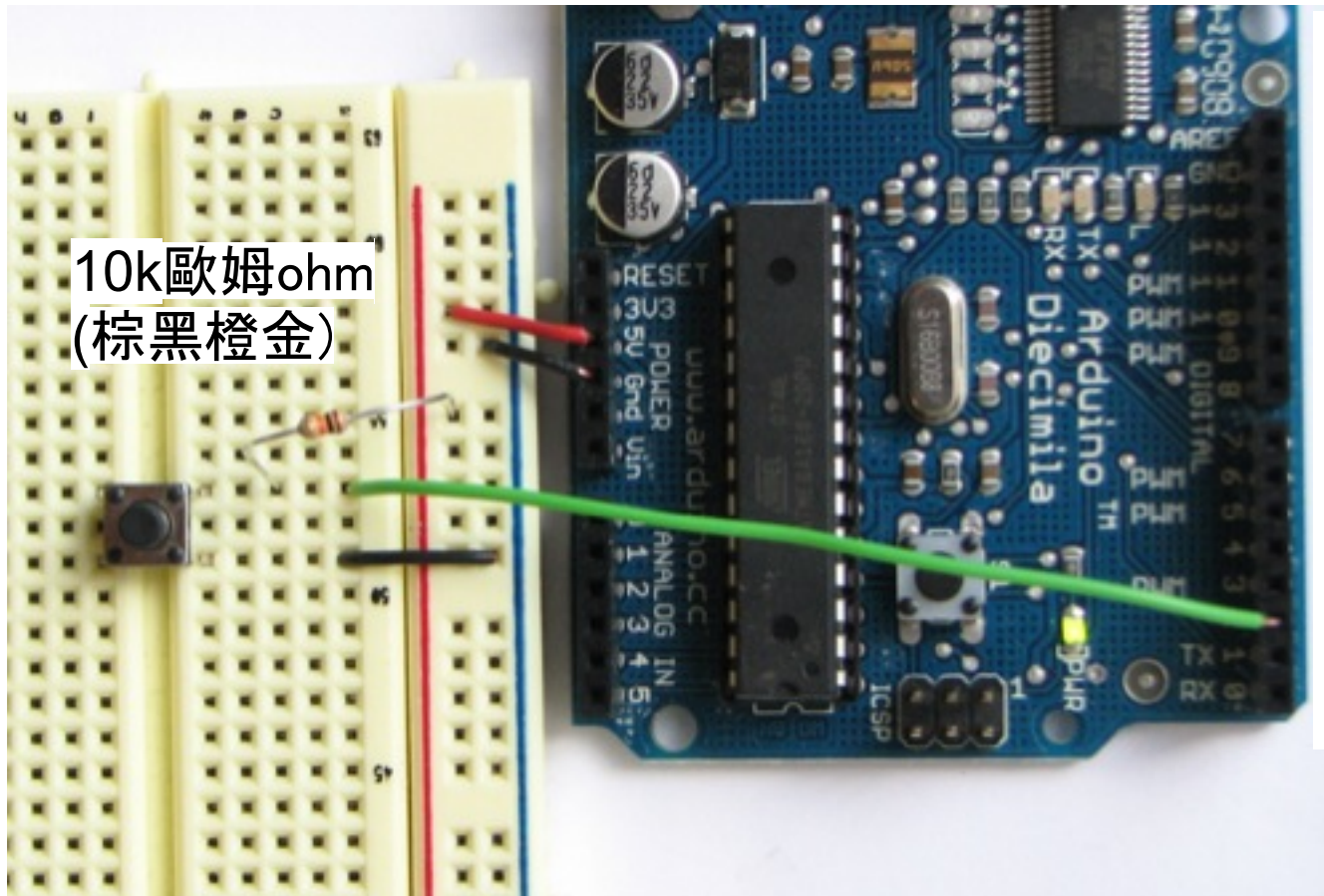

程式檔: [Arduino IDE的File > Sketchbooks > Example > Digital > Button](#)

圖片來源: <http://arduino.cc/en/Tutorial/Button>

Button (接法一) 程式碼解說

```
int ledPin = 13;    //設定第13 pin給LED燈
int inPin = 2;     //設定第2 pin為輸入pin (為了讀取按鈕狀態)
int val = 0;      //讀取按鈕狀態

void setup() {
  pinMode(ledPin, OUTPUT); //設定LED pin腳狀態為輸出
  pinMode(inPin, INPUT);  //設定第2 pin狀態為輸入
}

void loop(){
  val = digitalRead(inPin); //讀取輸入pin腳的值
  if (val == HIGH) {       //確認是否輸入為高電壓 (按鈕壓下)
    digitalWrite(ledPin, LOW); //給pin腳低電壓 (關掉LED燈)
  } else {
    digitalWrite(ledPin, HIGH); //給pin腳高電壓 (開啟LED燈)
  }
}
```

範例三 Button (接法二)

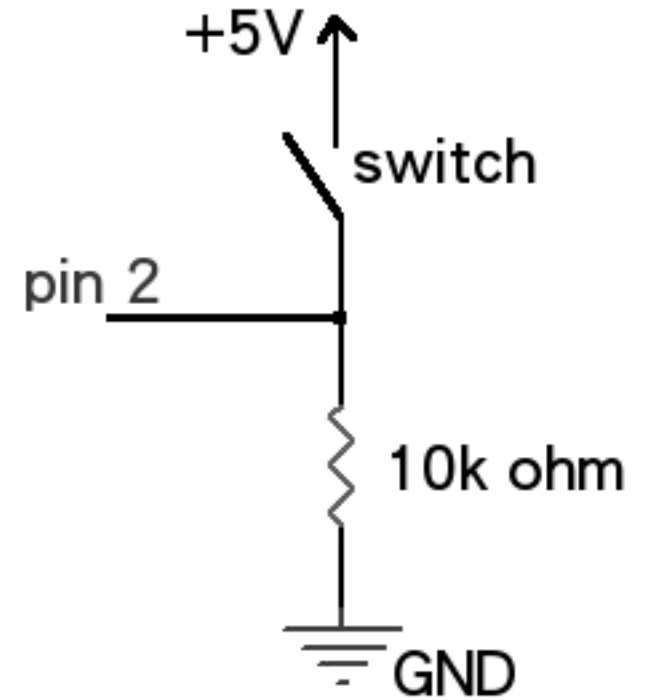
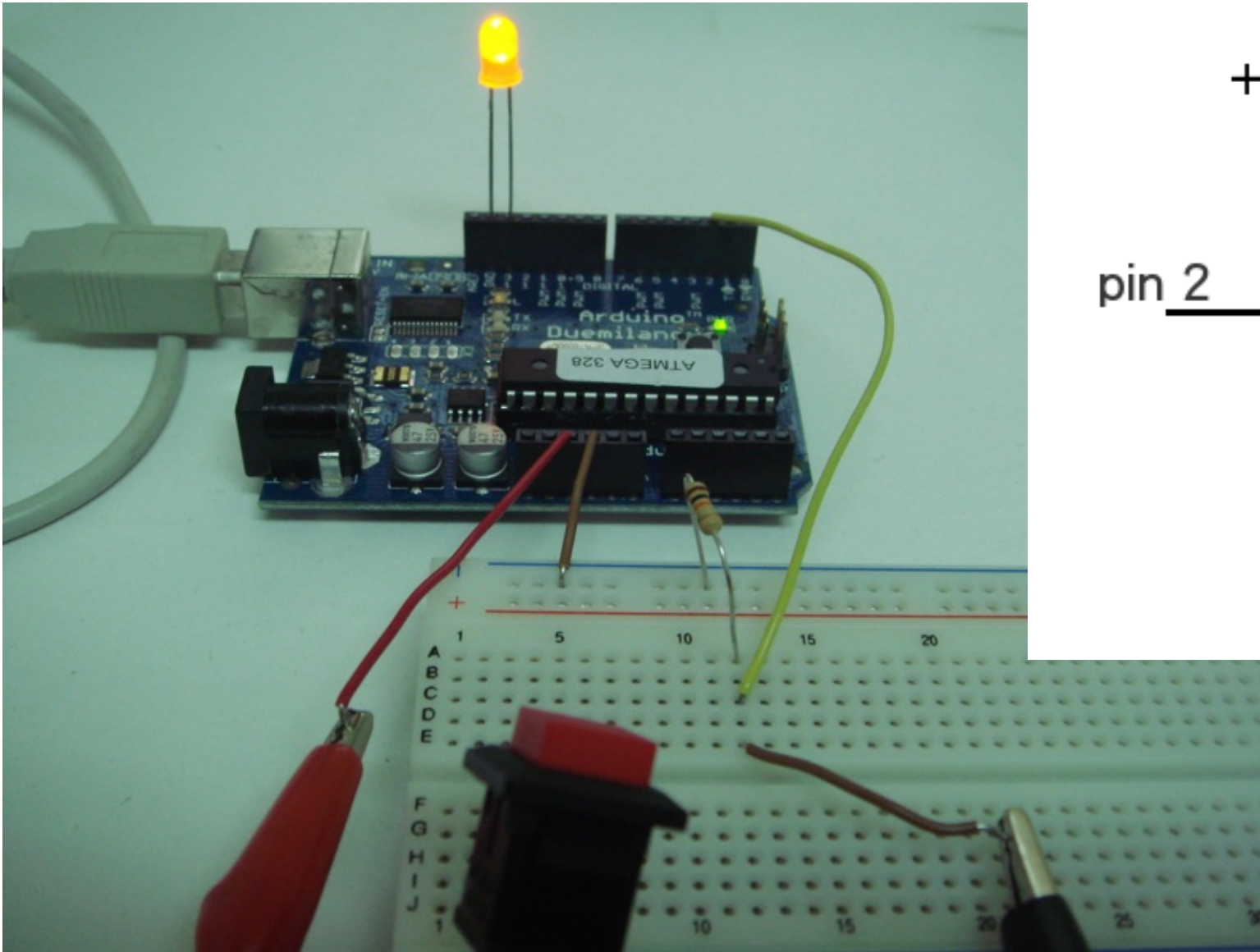

參考資料

- Arduino官網 <http://arduino.cc>
- Arduino樂園 <http://arduino.tw/>
- 小毛的Interactive2Go <http://interactive2go.blogspot.com>
- ladyada的Arduino Tutorail <http://www.ladyada.net/learn/arduino/index.html>
- 基本電學常識 <http://tw.group.knowledge.yahoo.com/primary-school/listitem/view?iid=190>
- 電阻色碼計算 http://samengstrom.com/nxl/3660/4_band_resistor_color_code_page.en.html
- 線上相關電學計算網站 <http://bbs.audiohall.net/viewtopic.php?t=1337&sid=999ddd2b9f932f45c95e192388a5dfa3>
- 電阻概論 <http://sun.cis.scu.edu.tw/~lab/knowledge/r.htm>
- 歐姆定律 http://en.wikipedia.org/wiki/Ohm%27s_law